

Ideas in motion

Conveyor and power transmission belts



General catalogue



Index

2	The company
4	Conveyor and process belts
6	Production program
12	Lateral profiles, longitudinal guides and sidewalls
14	Special applications
16	Flat transmission belts
18	Production program
21	Polyurethane round and V-belts
22	Equipment and jointing systems
24	Fast Joint equipment
26	Punchers, skivers, welders
27	Presses
28	“Texgum” roller coverings
30	Endless rubber mandril made belts
32	Rubber and silicone sheeting
34	Worldwide network of distribution and sale
36	Headquarters and italian associated companies

The company

CHIORINO S.p.A., founded in Biella in 1906, is today an international leading company in the full-cycled production of conveyor and transmission belts for any application, in any industrial field and in the service industry

The production

The production systems designed and built to CHIORINO specifications afford the company many different techniques to process any type of material. The complete production autonomy of the company is a guarantee of reliable and consistently high quality products. Using advanced spreading, calendering, laminating and blending lines, CHIORINO produce:

- ▶ **Conveyor and process belts in polyurethane, PVC, elastomer and silicone**
- ▶ **Power transmission belts**
- ▶ **Polyurethane round and V-belts**
- ▶ **“Texgum” roller coverings**
- ▶ **Rubber cots and aprons**

Today’s market requires specialization, flexibility and technological innovation, as well as the sensitivity to understand how to interpret the needs of customers. CHIORINO responds perfectly to the needs of every sector, offering products that are custom-designed, highly technological and of superior quality.

CHIORINO also provides custom finishing of the product in its own factories. The combination of multiple expertise and technology make it possible to CHIORINO to personalize its products; its engineers work with customers to study the most appropriate solution and monitor the process from start to finish.



The Research & Development

CHIORINO laboratories are equipped with advanced and constantly evolving scientific instruments monitoring the rheological, chemical and physical-mechanical analysis of the polymeric materials. They have always focused their work on researching and developing new materials, polyurethanes, elastomeric blends and new textile fabrics to ensure innovative solutions capable of anticipating and meeting all market demands.



The Service

CHIORINO is active worldwide through a network made of 18 Associates and more than 60 between exclusive distributors and specialized service centres, all of these highly qualified to provide quick assistance and on site fitting twenty-four hours a day.



The Quality

CHIORINO's policy toward **quality assurance systems and environmental protection** is extremely rigorous and complies with the strictest international standards.

Quality management involves the entire process of design, production, marketing and post-sales services.

Environmental protection entails pollution prevention and maximum disclosure to the community and local authorities, limiting environmental impact to a minimum.

This strategy earned CHIORINO **UNI EN ISO 9001:2008** and **UNI EN ISO 14001:2004** certification and it was also one of the first major Italian companies to earn **EMAS** validation (Eco Management and Audit Scheme).



Conveyor and process belts

CHIORINO's full-cycled production equipment includes sophisticated calendering and spread-coating lines that treat raw materials and combine them with other components to obtain, as the end product, conveyor and process belts for light and medium duty, suitable for any industrial field.

The standard production range includes belts with textile carcass made of polyester, cotton, polyamide or fiberglass, covered with:

- ▶ POLYURETHANE
- ▶ PVC
- ▶ ELASTOMER
- ▶ SILICONE

The endless making

CHIORINO is able to perform all necessary operations in its highly automated workshops including finger punching, skiving, pressing, edge trimming, for the fabrication of endless belt manufacture.

Belts can be supplied endless spliced or with prepared ends for on-site splicing, to be done with dedicated solutions and CHIORINO designed equipment (see page 22).

Special belts can also be manufactured complete with:

- ▶ **guides, profiles and sidewalls fitted by means of high frequency and hot air welding machines**
- ▶ **perforations**
- ▶ **special corrugated and finger profiles for belts used in the fruit and vegetable industry**
- ▶ **special corrugated and finger profiles for belts used in the fruit and vegetable industry**
- ▶ **personalization with customised logo**
- ▶ **special design/cut to suit curve conveyors.**

CHIORINO's ENGINEERING DIVISION designs for its own workshops and those of its Sister Companies and Distributors all the equipment for the fabrication of conveyor and transmission belts. This important technical knowledge guarantees precision to a high standard throughout the world, ensuring ease of use and reliability.



Features of CHIORINO belts

- ▶ antistatic and non-conductive
- ▶ flame retardant (in compliance with DIN 22103, ISO 340 standards and UL94)
- ▶ food compliant according to EU regulations EC 1935/2004, EC 2023/2006, EU 10/2011, FDA, USDA
- ▶ resistance to abrasion, oils, fats and chemicals
- ▶ surfaces with low, medium or high coefficient of friction
- ▶ high and low temperature resistance
- ▶ high transverse rigidity and dimensional stability
- ▶ low noise (LdB belts)
- ▶ smooth or textured surfaces



Applications

- ▶ Food industry (bakery, meat and seafood, confectionary, dairy)
- ▶ Fruit and vegetables
- ▶ Paper and box folding industry
- ▶ Printing and publishing
- ▶ Postal automation
- ▶ Logistic (airports, materials handling, commercial distribution)
- ▶ Textile industry
- ▶ Packaging and wrapping
- ▶ Chemicals and pharmaceuticals
- ▶ Woodworking and furniture
- ▶ Tanning
- ▶ Mechanical, metallurgical and automobile
- ▶ Marble, granite, brick, ceramics and glass
- ▶ Sports equipment
- ▶ Renewable energy



Production program

6

Type	Food compliance (1)	Permanent antistatic	Low noise fabric on driving surface (2)	Colour of the conveying surface	Total thickness	Weight	Minimum diameter (3)	Pull for 1% elongation	Max. admissible pull	Min. temperature resistance	Max. temperature resistance	Comparative coefficient of friction (4)	Maximum production width	
					mm	kg/m ²	mm	N/mm	N/mm	[°C]	[°C]	mm	mm	
POLYURETHANE														
1M3 U0-U2 HP blue A	✓	✓		●	0.70	0.70	→	4	4	-30	110	MF	2000	
1M5 U0-U2 A	✓	✓		●	0.70	0.80	→	5	5	-20	100	MF	2000	
1M5 U0-U2 D W A	✓	✓		○	0.70	0.70	→	5	5	-30	100	HF	2000	
1M5 U0-U2 HP blue S A	✓	✓		●	0.70	0.70	→	5	5	-30	110	HF	2000	
1M5 U0-U2 HP W A	✓	✓		○	0.70	0.80	→	5	5	-30	110	MF	2000	
1M5 U0-U2 HP W S A	✓	✓		○	0.70	0.80	→	5	5	-30	110	HF	2000	
1M5 U0-U2 HP VL blue A	✓	✓		●	0.70	0.80	→	5	5	-30	110	MF	2000	
1M5 U0-U2 W A	✓	✓		○	0.70	0.80	→	5	5	-20	100	LF	2000	
1M5 U0-U2 W A LF VL	✓	✓		○	0.70	0.80	→	5	5	-20	100	LF	1500	
1M5 U0-U2 PN yellow	✓	✓		●	1.10	0.90	→	5	5	-20	100	HF	2000	
1T6 U0-U2 HP W A	✓	✓		○	0.80	0.80	→	6	6	-30	110	MF	2000	
1M6 U0-U5 FL	✓	✓	✓	●	1.00	1.00	→	10	6	-20	100	MF	2000	
1M6 U3-U3 FL	✓	✓		●	1.20	1.30	→	10	6	-20	100	MF	2000	
1M6 U5-U5 FL	✓	✓		●	1.60	1.90	→	20	6	-20	100	MF	2000	
1M12 U0-U3 HP PN N S	✓	✓	✓	●	1.50	1.60	→	8	12	-30	110	HF	2000	
ST06	✓	✓		●	0.60	0.60	→	10	4	-30	100	MF	2000	
2M5 U0-U0 HP A	✓	✓		○	1.00	1.00	→	6	12	-30	110	LF	2000	
2M5 U0-U1 blue S A	✓	✓		●	1.30	1.30	→	6	12	-20	100	HF	2000	
2M5 U0-U1 W S A	✓	✓		○	1.30	1.50	→	6	12	-20	100	HF	2000	
2M5 U0-U2 A	✓	✓		●	1.20	1.40	→	6	12	-20	100	LF	2000	
2M5 U0-U2 W A	✓	✓		○	1.30	1.50	→	6	12	-20	100	MF	2000	
2M5 U0-U2 LF W A	✓	✓		○	1.30	1.50	→	6	12	-20	100	LF	2000	
2M5 U0-U2 HP blue A	✓	✓		●	1.30	1.40	→	6	12	-30	110	MF	2000	
2M5 U0-U2 HP blue S A	✓	✓		●	1.30	1.40	→	6	12	-30	110	HF	2000	
2M5 U0-U2 HP W A	✓	✓		○	1.30	1.40	→	6	12	-30	110	MF	2000	
2M5 U0-U2 HP W S A	✓	✓		○	1.30	1.40	→	6	12	-30	110	HF	2000	
2M5 U0-U2 HP PN W A	✓	✓		○	1.60	1.50	→	6	12	-30	110	MF	2000	
2M5 U0-U2 HP VL blue A	✓	✓		●	1.30	1.40	→	6	12	-30	110	MF	2000	
2M5 U0-U2 HP PN blue A	✓	✓		●	1.60	1.50	→	6	12	-30	110	MF	2000	
2M5 U2-U2 HP VL blue A	✓	✓		●	1.50	1.70	→	10	6	-30	110	MF	2000	
2M5 U0-U8 HP CC blue	✓	✓		●	2.90	2.10	→	10	6	-30	110	HF	600	
2M5 U0-U15 HP ST W A	✓	✓		○	3.50	2.70	→	50	5	-30	110	MF	2000	
2MT5 U0-U2 N FDA	✓	✓		●	1.80	2.10	→	30	6	-10	60	LF	2000	
2MT6 U0-0 HP	✓	✓		○	1.50	1.40	→	6	12	-30	100	LF	2000	
2M8 U0-U0	✓	✓		○	1.30	1.40	→	8	16	-20	100	LF	2000	
2M8 U0-U0 SP	✓	✓		○	1.30	1.10	→	8	16	-20	100	LF	3000	
2M8 U0-U0 GR	✓	✓		○	1.30	1.40	→	8	16	-20	100	LF	2000	
2M8 U0-U0 GR SP	✓	✓		○	1.30	1.10	→	8	16	-20	100	LF	3000	
2T8 U0-0	✓	✓		○	1.30	1.40	→	8	16	-20	100	LF	3000	
2M8 U0-U2	✓	✓		●	1.40	1.60	→	8	16	-20	100	LF	2000	
2M8 U0-U2 SP	✓	✓		●	1.50	1.60	→	8	16	-20	100	LF	3500	
2M8 U0-U2 W A SP	✓	✓		○	1.50	1.50	→	8	16	-20	100	LF	3500	
2M8 U0-U2 N HC	✓	✓		●	1.60	1.60	→	8	16	-20	100	LF	2000	
2M8 U0-U2 N SP	✓	✓		●	1.40	1.40	→	8	16	-20	100	LF	3500	
2M8 U0-U5 TR	✓	✓		○	1.70	2.00	→	8	16	-20	100	LF	2000	
2T12 U0-U2 W SP	✓	✓		○	1.60	1.80	→	30	12	24	-20	100	LF	3000
2T12 U0-U2 HP VL W A	✓	✓		○	1.60	1.70	→	12	24	-30	110	MF	2000	
2M12 U0-U3 R A	✓	✓		●	1.70	1.80	→	40	12	24	-20	100	LF	2000
2M12 U0-U3 R W A	✓	✓		○	1.70	1.80	→	40	12	24	-20	100	LF	2000
2M12 U0-U3 R N A	✓	✓		●	1.70	1.80	→	40	12	24	-20	100	LF	2000
2M12 U0-V-U5	✓	✓	✓	●	2.00	2.50	→	60	12	24	-10	60	LF	2000
2M12 U0-V-U5 SP	✓	✓	✓	●	2.10	2.50	→	60	12	24	-10	60	LF	3000
2M12 U0-U10 W A	✓	✓	✓	○	2.40	2.70	→	50	12	24	-20	100	LF	2000
2M12 V5-V-U10 W	✓	✓		○	3.50	4.00	→	80	12	24	-10	60	LF	2000
2M12 U0-U15 LT W A	✓	✓	✓	○	6.00	3.50	→	50	12	24	-20	100	MF	500
2M12 U0-U17	✓	✓	✓	●	3.40	3.80	→	80	12	24	-20	100	LF	2000
3M8 U0-U3	✓	✓		●	2.20	2.40	→	60	10	20	-20	100	LF	2000
3M8 U0-U5 HP blue A	✓	✓		●	2.30	2.40	→	60	10	20	-30	110	MF	2000
3M18 U0-V-U10	✓	✓	✓	●	3.70	4.40	→	100	18	36	-10	60	LF	2000
3M18 U0-V-U10 SP	✓	✓	✓	●	3.70	4.40	→	100	18	36	-10	60	LF	3000
3M18 U0-V-U30 blue	✓	✓		●	6.00	7.00	→	200	15	30	-10	60	MF	2000
PB														
PB-215		✓		●	2.15	2.20	→	80	20	20	-30	110	MF	2100
PB-265		✓		●	2.65	2.90	→	100	20	20	-30	110	MF	2100
PB-330		✓		●	2.30	2.70	→	60	10	16	-10	80	LF	3400
PB-365		✓		●	2.60	3.00	→	100	20	20	-10	80	LF	3400

Type	Food compliance (1)	Permanent antistatic	Low noise fabric on driving surface (2)	Colour of the conveying surface	Total thickness	Weight	Minimum diameter (3)	Pull for 1% elongation	Max. admissible pull	Min. temperature resistance	Max. temperature resistance	Comparative coefficient of friction (4)	Maximum production width
					mm	kg/m ²	mm	N/mm	N/mm	[°C]	[°C]	mm	mm
ELASTIC													
EL2-U10 FL	✓	✓		●	1.00	1.20	10	2 ⁽⁵⁾	2	-20	60	MF	2000
EL2-U10 W	✓			○	1.00	1.00	10	2 ⁽⁵⁾	2	-20	60	LF	2000
EL2-U10 HP W	✓			○	1.00	1.10	10	2 ⁽⁵⁾	2	-30	60	MF	2000
EL2-U10 HP blue	✓			●	1.00	1.10	10	2 ⁽⁵⁾	2	-30	60	MF	2000
EL3-U15 FL	✓	✓		●	1.50	1.60	10	3 ⁽⁵⁾	3	-20	60	MF	2000
EL3-U15 HP PN blue	✓			●	1.50	1.40	10	3 ⁽⁵⁾	3	-30	60	MF	2000
EL4-U20 W	✓			○	2.00	2.20	10	4 ⁽⁵⁾	4	-20	60	LF	2000
EL4-U20 FH	✓			●	2.10	2.10	10	4 ⁽⁵⁾	4	-20	60	MF	2000
PT													
PT0.9 0-0		✓		●	0.90	0.90	10	5	10	-20	100	LF	1200
PT0.9 0-0 N		✓		●	0.90	0.90	10	5	10	-20	100	LF	1200
PT1.0 0-U4		✓		●	1.00	1.00	10	5	5	-20	100	HF	1500
PT1.0 U1-U3		✓		●	1.00	1.10	10	5	5	-20	100	HF	1500
PT1.2 U2-U5		✓		●	1.20	1.30	20	5	5	-20	100	HF	1500
PT1.2 0-U2		✓		●	1.20	1.30	20	6	12	-20	100	HF	1500
PT1.4 EL G3-G3 FL		✓		●	1.40	1.50	15	2.5	2.5	-10	60	HF	1200
PT1.4 EL G3-G3 SK		✓		●	1.40	1.50	15	2.5	2.5	-10	60	HF	1200
PT1.4 G3-G3		✓		●	1.40	1.60	15	6	6	-20	100	HF	1200
PT1.5 0-G3 FL		✓		●	1.50	1.80	25	6	12	-20	100	MF	1200
PT1.8 0-0		✓		●	1.80	1.80	20	9	16	-20	100	LF	2000
PT1.8 G1-0		✓		○	1.80	1.80	20	9	16	-20	100	LF	2000
POLYAMIDE													
PRO-L		✓		●	0.90	0.80	15	2	4	0	100	LF	500
P1-L		✓		●	1.25	1.20	25	2	6	0	100	LF	500
CNG		✓		●	0.70	0.70	20	2	4	-20	100	MF	1200
CNPG		✓		●	1.00	0.90	20	2	4	0	100	MF	500
N		✓		●	0.60	0.60	15	2	4	-20	100	LF	1200
N8		✓		●	1.00	0.90	15	3	6	-20	100	LF	1200
NT1 HS		✓		●	1.20	1.20	15	3	6	-20	100	MF	1200
NT2 HS		✓		●	2.00	2.10	20	3.5	7	-20	100	MF	1200
NT3 HS		✓		●	3.00	3.20	40	6	12	-20	100	MF	1200
NT4 HS		✓		●	4.00	4.30	60	6	12	-20	100	MF	1200
ELASTOMER													
2M8 U0-U-G5 HS FL		✓		●	2.00	2.40	25	8	16	-20	100	MF	1200
2M8 U0-U-G10 FH		✓		●	2.30	2.40	50	8	16	-20	100	HF	1200
2M8 U0-U-G15 HS FL		✓		●	3.00	3.40	50	8	16	-20	100	MF	1200
2M8 U0-U-G10TP LG		✓		●	2.80	2.70	30	8	16	-20	100	HF	2000
2T12 U0-U-G10 HS FH		✓		●	2.20	2.20	50	12	24	-20	100	HF	1200
2M12 U0-G25 GP		✓		●	5.50	4.50	60	12	24	-40	100	HF	1200
2T12 U0-G25 HS GP		✓		●	5.50	4.50	80	12	24	-40	100	HF	1200
2T12 U0-G35 HS GP		✓		●	6.50	6.50	80	12	24	-40	100	HF	1200
2M12 0-G-0 R		✓		○	2.00	2.10	50	10	20	-10	100	LF	1200
3M12 0-G-0		✓		○	2.80	3.10	50	15	30	-10	100	LF	1200
DG2/70 HS GP blue		✓		●	6.40	6.00	100	7.5	15	0	100	HF	500
MF ELASTOMER													
2T12 U0-U-G15 MF		✓		●	2.80	3.40	50	12	24	-20	100	HF	1200
3M18 U0-U-G40 MF		✓		●	5.70	5.90	100	18	36	-20	100	HF	1200
3M18 U0-U-G60 MF		✓		●	7.30	8.30	100	18	36	-20	100	HF	1200
NT5 MF		✓		●	5.00	5.50	50	6	12	-20	100	HF	1200
DG1/45 MF		✓		●	4.50	5.10	50	5	10	0	100	HF	500
DG2/60 MF		✓		●	6.50	7.10	75	7.5	15	0	100	HF	500
SILICONE													
1M6 U0-S0	✓	✓	✓	○	0.60	0.40	20	6	6	-30	100	HF	2000
2M5 U0-U-S2 W	✓	✓		○	1.30	1.40	→	6	12	-30	100	HF	2000
2M8 U0-U-S0		✓		○	1.30	1.10	30	8	16	-20	100	LF	2000
2MT8 S0-S0		✓		○	1.20	1.10	30	8	16	-40	160	LF	2000
2MT8 S0-S2	✓	✓		○	1.30	1.30	30	8	16	-40	160	HF	2000
SILON													
SILON 25 W	✓			○	2.50	1.30	30	10	10	-20	120	LF	2000
SILON 25 HC		✓		●	2.50	1.45	30	10	10	-20	120	LF	2000
SILON 40 HC		✓		●	4.00	2.40	60	10	10	-20	120	LF	2000
SILON 60 HC		✓		●	5.50	3.40	100	10	10	-20	120	LF	2000
SILON 60 NA				●	5.50	3.40	100	10	10	-20	120	LF	2000
P4													
P4		✓		●	3.40	3.70	200	20	40	0	100	LF	2000
P4/N		✓		●	3.40	3.70	200	20	40	0	100	LF	2000
P4/P		✓		●	3.10	3.50	200	20	40	0	100	LF	2000

Production program

8

Type	Food compliance (1)	Permanent anti-static	Low noise fabric on driving surface (2)	Colour of the conveying surface	Total thickness	Weight	Minimum diameter (3)	Pull for 1% elongation	Max. admissible pull	Min. temperature resistance	Max. temperature resistance	Cooperative coefficient of friction (4)	Maximum production width
					mm	kg/m ²	mm	N/mm	N/mm	[°C]	[°C]	mm	mm
PVC													
1M6 U0-V3 A N		✓		●	0.8	0.8	20	6	6	-10	60	LF	3500
1M6 U0-V5	✓	✓	✓	●	1.0	1.1	20	6	6	-10	60	MF	3000
1M6 U0-V5 W	✓	✓	✓	○	1.0	1.1	20	6	6	-10	60	MF	3000
1M6 U0-V5 N		✓	✓	●	1.0	1.1	20	6	6	-10	60	LF	3000
1M6 U0-V5 FM N		✓	✓	●	1.1	1.0	30	6	6	-10	60	LF	3000
1M6 U0-V5 SM N		✓	✓	●	1.0	1.1	20	6	6	-10	60	LF	2000
1M6 V5-V5	✓	✓		●	1.8	2.0	30	6	6	-10	60	MF	3000
1M12 U0-V5 N		✓	✓	●	1.8	2.0	30	8	12	-10	60	LF	2000
1M12 U0-V5 FH N		✓	✓	●	2.0	2.1	30	8	12	-10	60	MF	2000
1M12 U0-V5 SM N		✓	✓	●	2.1	2.0	30	8	12	-10	60	LF	2000
2T5 0-V-0	✓	✓		○	1.6	1.7	20	5	10	-10	60	LF	2000
2MT5 U0-V3 N		✓	✓	●	1.8	2.0	20	6	12	-10	60	LF	3000
2MT5 U0-V3 FH N		✓		●	2.1	1.9	30	6	12	-10	60	MF	2000
2MT5 U0-V3 SM N		✓	✓	●	1.9	2.0	20	6	12	-10	60	LF	2000
2M8 U0-V-U0	✓	✓		○	1.5	1.5	30	8	16	-10	60	LF	3000
2T8 U0-V-0	✓			○	1.4	1.4	30	8	16	-10	60	LF	3000
2M8 U0-V5 A	✓	✓		●	2.0	2.3	30	8	16	-10	60	MF	3500
2M8 U0-V5 W	✓			○	2.0	2.3	30	8	16	-10	60	MF	3000
2M8 U0-V5 PN W	✓			○	2.2	2.3	30	8	16	-10	60	MF	2000
2M8 U0-V5 blue	✓			●	2.0	2.3	30	8	16	-10	60	MF	3000
2M8 U0-V5 FM	✓	✓		●	2.1	2.3	30	8	16	-10	60	MF	3000
2M8 U0-V5 FM N		✓		●	2.1	2.3	30	8	16	-10	60	HF	3000
2M8 U0-V5 PS GR		✓		○	2.3	2.3	30	8	16	-10	60	HF	500
2M8 U0-V5 RT GR		✓		○	2.2	2.3	30	8	16	-10	60	HF	2000
2M8 V5-V5 W	✓			○	2.5	3.0	50	8	16	-10	60	MF	2000
2M8 V5-V5 blue	✓			●	2.5	3.0	50	8	16	-10	60	MF	2000
2M8 U0-V17 GP		✓		●	5.2	3.7	50	8	16	-10	60	HF	2000
2M10 U0-V10	✓			●	2.8	3.3	50	10	20	-10	60	MF	3000
2M10 U0-V10 W	✓			○	2.8	3.3	50	10	20	-10	60	MF	3000
2M10 U0-V10 blue	✓			●	2.8	3.1	50	10	20	-10	60	MF	3000
2M12 U0-V-U0 GR		✓	✓	○	1.7	1.6	40	12	24	-10	60	LF	3000
2T12 U0-V0				●	2.5	2.6	80	12	24	-10	60	LF	2000
2M12 U0-V3		✓	✓	●	1.9	2.1	40	12	24	-10	60	LF	3000
2M12 U0-V3 N		✓	✓	●	1.9	2.1	40	12	24	-10	60	LF	3000
2M12 U0-V7 LG		✓	✓	●	2.4	2.4	40	12	24	-10	60	HF	2000
2M12 U0-V8 RT		✓	✓	●	2.3	2.4	40	12	24	-10	60	HF	2000
2M12 U0-V10 A	✓	✓	✓	●	2.5	2.9	50	12	24	-10	60	MF	3500
2M12 U0-V10 W	✓		✓	○	2.5	2.9	50	12	24	-10	60	MF	3000
2M12 U0-V10 N		✓	✓	●	2.9	3.5	60	12	24	-10	60	LF	3000
2M12 U0-V10 RT	✓	✓	✓	●	2.6	2.6	50	12	24	-10	60	HF	2000
2T12 U0-V10	✓	✓		●	2.5	2.9	50	12	24	-10	60	MF	3000
2T12 U0-V10 W	✓			○	2.5	2.9	50	12	24	-10	60	MF	3000
2M12 V5-V10	✓			●	3.0	3.5	80	12	24	-10	60	MF	2000
2M12 V5-V10 W	✓			○	3.1	2.8	80	12	24	-10	60	MF	2000
2T12 V5-V10 W	✓			○	3.0	3.5	80	12	24	-10	60	MF	2000
2T12 V5-V10 blue	✓			●	3.1	3.5	80	12	24	-10	60	MF	2000
2M12 U0-V15 W	✓		✓	○	3.0	3.4	80	12	24	-10	60	MF	3000
2M12 U0-V15 CL W	✓		✓	○	5.5	3.5	80	12	24	-10	60	MF	2000
2M12 U0-V15 FB W	✓		✓	○	4.1	3.5	80	12	24	-10	60	MF	2000
2M12 U0-V15 GPL N		✓	✓	●	3.8	3.5	60	12	24	-10	60	HF	2000
2M12 U0-V15 ST W	✓		✓	○	3.6	3.5	80	12	24	-10	60	MF	2000
2M12 U0-V20 GP		✓	✓	●	5.5	3.9	50	12	24	-10	60	HF	2000
2T12 U0-V20 GP W	✓			○	5.5	3.9	50	12	24	-10	60	HF	2000
2T20 V10-V10 W A	✓	✓		○	4.5	5.4	120	20	40	-10	60	MF	2000
2M20 U0-V25 RT	✓		✓	●	5.0	5.7	100	20	40	-10	60	MF	2000
3T18 U0-V0				●	3.7	3.9	120	18	36	-10	60	LF	2000
3M18 U0-V15 A	✓	✓	✓	●	4.2	4.9	100	18	36	-10	60	MF	3500
3M18 U0-V15 W	✓		✓	○	4.2	4.9	100	18	36	-10	60	MF	3000
3T18 U0-V15	✓	✓		●	4.2	4.9	100	18	36	-10	60	MF	3000
3T18 U0-V15 W	✓			○	4.2	5.0	100	18	36	-10	60	MF	3000
3T18 V10-V20 W	✓	✓		○	6.7	7.9	100	18	36	-10	60	MF	2000
3T30 V10-V10 W	✓	✓		○	6.3	7.4	200	30	60	-10	60	MF	2000
3M30 U0-V25 RT	✓		✓	●	6.6	7.8	200	30	60	-10	60	MF	2000

Type	Food compliance (1)	Permanent anti-static	Low noise fabric on driving surface (LdB) (2)	Colour of the conveying surface	Total thickness	Weight	Minimum diameter (3)	Pull for 1% elongation	Max. admissible pull	Min. temperature resistance	Max. temperature resistance	Comparative coefficient of friction (4)	Maximum production width
					mm	kg/m ²	mm	N/mm	N/mm	[°C]	[°C]	mm	mm
PVC FLAME RETARDANT													
1M12 U0-V5 PN FR	✓	✓	●		1.8	1.9	40	8	12	-10	60	HF	2000
2M5 U0-V5 PN FR	✓		●		1.9	2.1	40	6	12	-10	60	HF	2000
2M12 U0-V-U0 FR	✓	✓	●		2.5	2.5	40	12	24	-10	60	LF	2000
2M12 U0-V5 FR	✓	✓	●		2.2	2.4	50	12	24	-10	60	LF	2000
2M12 U0-V7 LG FR	✓	✓	●		2.7	2.4	40	12	24	-10	60	HF	2000
2M12 U0-V10 RT FR	✓	✓	●		2.7	2.9	60	12	24	-10	60	HF	2000
2T12 U0-V10 FM FR	✓		●		2.6	2.9	50	12	24	-10	60	MF	3000
2M12 U0-V20 FB FR	✓	✓	●		4.6	3.9	50	12	24	-10	60	HF	2000
2M12 U0-V20 GP FR	✓	✓	●		5.5	3.9	50	12	24	-10	60	HF	2000
2M12 U0-V30 RL FR	✓	✓	●		8.5	5.8	60	12	24	-25	70	HF	1200
PVC AGR (6)													
2M8 U0-V5 AGR			●		2.0	2.2	30	8	16	-15	60	MF	3000
2M12 U0-V10 AGR		✓	●		2.5	2.9	50	12	24	-15	60	MF	3000
2M12 V5-V10 AGR			●		3.1	3.6	80	12	24	-15	60	MF	2000
2M12 V5-V10 AGR N			●		3.0	3.4	80	12	24	-15	60	MF	2000
2T12 V5-V10 AGR			●		3.1	3.6	80	12	24	-15	60	MF	2000
2T12 V10-V12 AGR			●		4.0	4.6	80	12	24	-15	60	MF	2000
3M15 U0-V15 AGR			●		4.1	4.6	100	18	36	-15	60	MF	3000
3M15 V5-V10 AGR			●		4.1	4.8	100	15	30	-15	60	MF	2000

The data of this table has been formulated under normal environment conditions. They are subject to alteration without notice.

- (1) Food compliant according to: EC 1935/2004, EC 2023/2006, EU 10/2011 and amendments, FDA, USDA (see technical data sheet).
- (2) The belts having a LdB bottom fabric give quiet running properties.
- (3) Minimum roller diameter is dependent on the joint recommended by CHIORINO.
- (4) Conveying surface coefficient of friction: LF low MF medium HF high
- (5) Elastic belts "EL": pull for 8% elongation.
- (6) The "AGR" range of belts is supplied only in rolls in the full manufactured width available at time of inquiry.

→: knife edge

COEFFICIENT OF FRICTION ON DRIVING SURFACE

Type of coating	Sliding bed		Motorized pulley	
	Raw steel sheet	Lamin. plastic or wood	Steel roller	Rubberized roller
0	0.20	0.25	0.20	0.30
G1	unsuitable		0.60	0.70
S0	0.30	0.40	0.30	0.50
U0	0.20	0.25	0.20	0.30
U2	0.40	0.50	0.30	0.40
U3, U5	0.40	0.50	0.40	0.60
V5, V10	unsuitable		0.40	0.60

TOLERANCES ON ENDLESS BELTS AND CUT LENGTHS WITH TEXTILE CARCASS

Widths (mm)			
10 ÷ 100	101 ÷ 500	501 ÷ 1000	1001 ÷ 3000
±2 mm	±4 mm	±6 mm	±10 mm
Lengths (mm)			
0 ÷ 2500	2501 ÷ 5000	5001 ÷ 10000	> 10000
± 0,5 %	± 0,4 %	± 0,3 %	± 0,2 %
These tolerances do not consider variations due to special environmental conditions.			

Explanation of type designation

BELTS WITH TEXTILE CARCASS

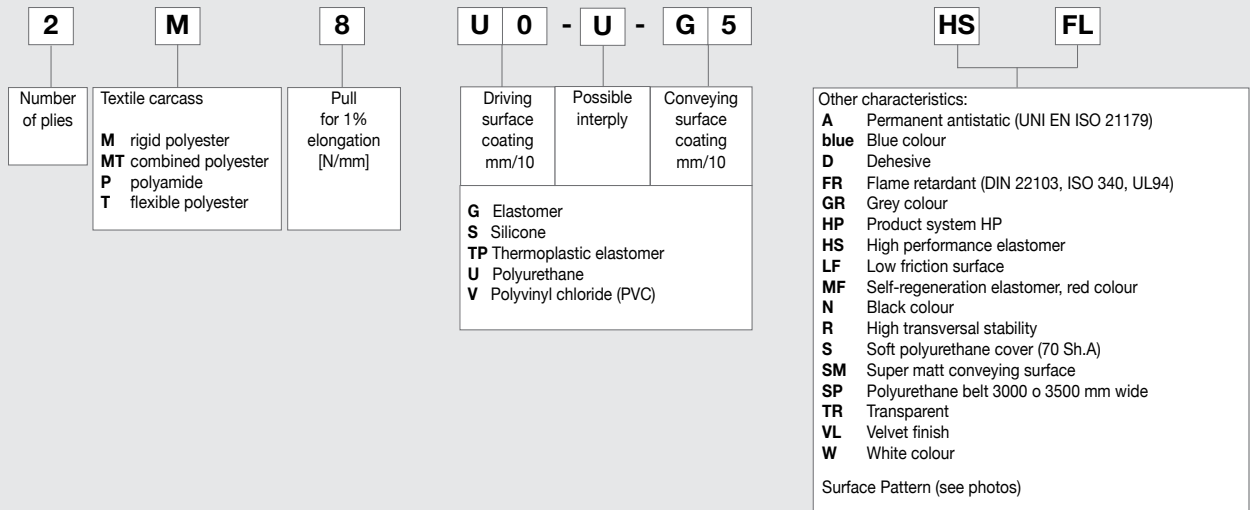

ELASTIC BELTS

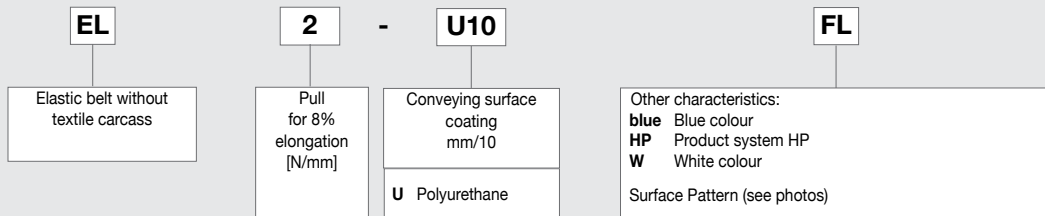

PT SERIES

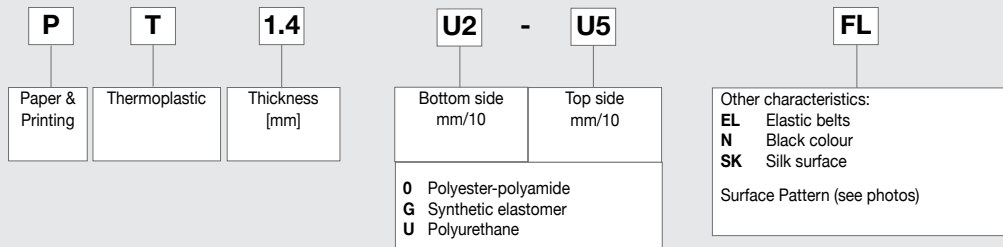

SILON

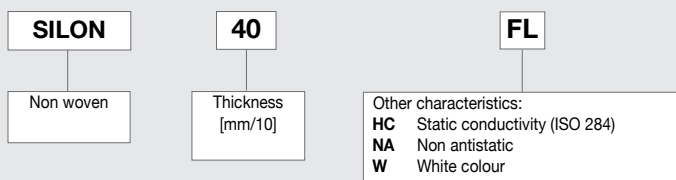

Surface patterns

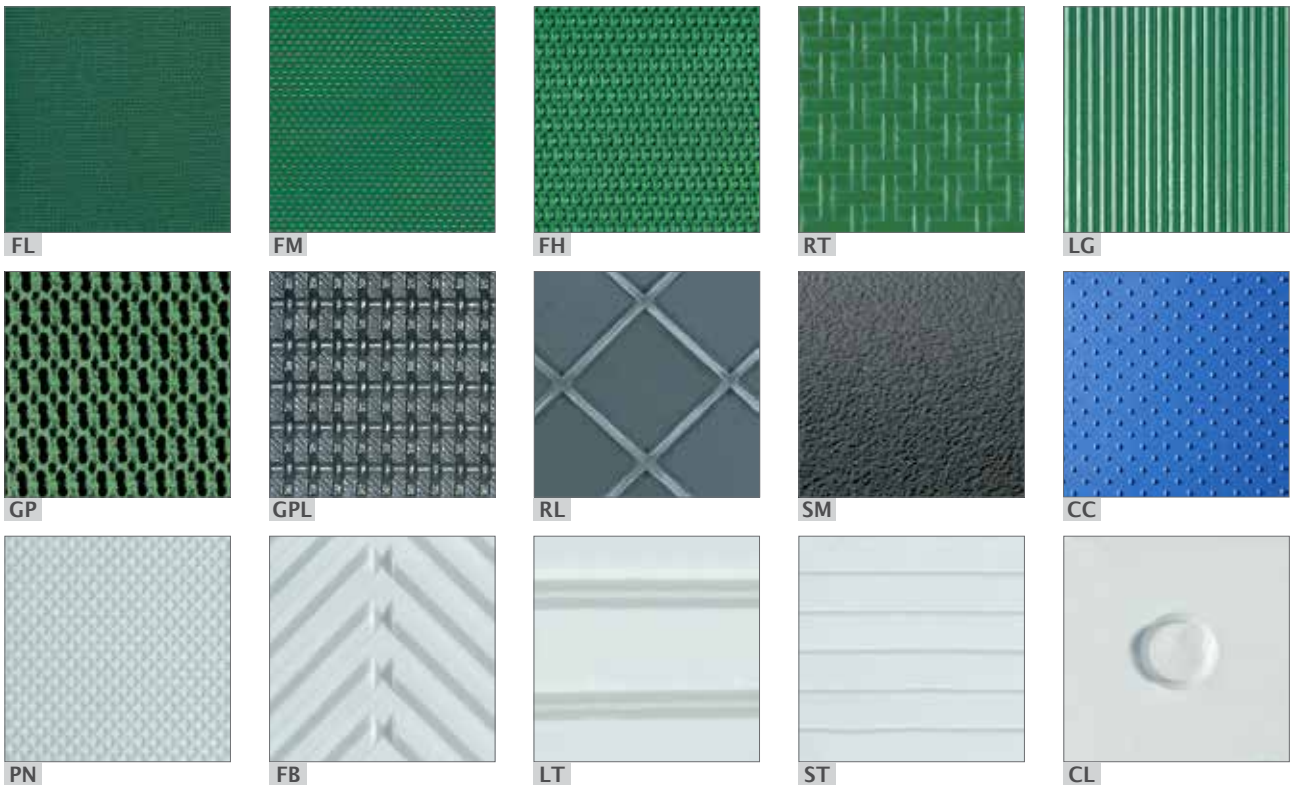

Configuration of the pulleys

Formulas to determine the values:	
Pulley width	$b = 1,1 \cdot b_0 + 10$ (mm)
Taper	$e = (d_e + 100) / 500$ (mm)
Cylindrical section according to the total width of the pulley	$b_c = b / 2$ (mm)

Legenda

- b**= pulley width
- b_c**= width of the cylindrical section
- b₀**= belt width
- d_e**= external diameter
- e**= taper

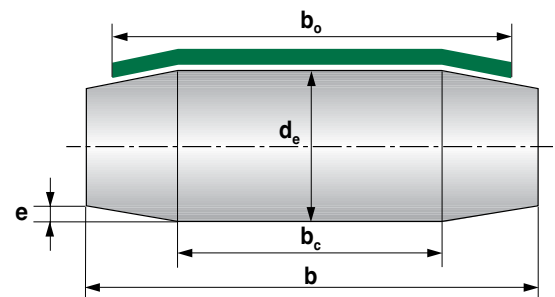

Lateral profiles, longitudinal guides and sidewalls



CHIORINO manufactures **profiles, guides and sidewalls** from special PVC and polyurethane compounds in various Sh.A hardnesses giving high flexibility and resistance to abrasion and oils.

They have been designed to be perfectly compatible with the conveyor belt covers and are fitted by means of different vulcanising systems which guarantee a perfect and long lasting bond using equipment normally available in all the fabrication workshops of CHIORINO.

- ▶ **Standard colours:** see tables. Special colours can be supplied on request.
- ▶ **Minimum pulley diameters:** the values of the minimum pulley diameters are meant as a guide only and they are based on a 2 mm thick belt, working at room temperature. The minimum pulley values which refer to K, KN and S profiles are valid only when fitted on the driving surface of the belt.
- ▶ In case of **back-flexing** (for K and S guides) diameters have to be increased by 50%.
- ▶ It is not advisable to fit KN guides longitudinally on the conveying surface. For the fitting of K, KN e S profiles please contact the CHIORINO Technical Support.

Profile	Type	Sizes	Thickness	Minimum diameter (1)	Hardness	Standard colours		Notes
		ØxHt				[mm]	[Sh.A]	
POLYURETHANE SIDEWALLS								
	C-U 10/20	10 x 20	1.7	50	85	✓	✓	Polyurethane sidewalls, without base, fitted longitudinally. They allow the use of small pulley diameters.
	C-U 10/30	10 x 30	1.7	70	85	✓	✓	
	C-U 10/40	10 x 40	1.7	100	85	✓	✓	
	C-U 10/50	10 x 50	1.7	120	85	✓	✓	
	C-U 20/60	20 x 60	1.7	150	85	✓	✓	
	C-U 20/80	20 x 80	1.7	190	85	✓	✓	
PVC SIDEWALLS WITH TEXTILE CORE								
	CV-T 10/20	10 x 20	1.7	60	60	✓	✓	Sidewalls with textile core, purposely designed to be applied on PVC belts on any thickness and number of plies for use in special applications (e.g. in food-processing, agriculture or for general conveying of loose bulk products).
	CV-T 10/30	10 x 30	1.7	80	60	✓	✓	
	CV-T 10/40	10 x 40	1.7	110	60	✓	✓	
	CV-T 10/50	10 x 50	1.7	140	60	✓	✓	
	CV-T 20/60	20 x 60	3.4	170	60	✓	✓	
	CV-T 20/80	20 x 80	3.4	210	60	✓	✓	

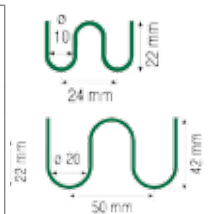

(1) Minimum pulley diameters referred to environment conditions of 20°C.

Profile	Type		Dim. b x h (mm)	Hardness (Sh.A)		Base		Standard colours			Minimum pitch (mm)		Long. min. diam. (mm) (L)		Transv. min. diam. (mm) (L)		Notes	
	PVC	PU		PVC	PUR	flat	grooved	Green	Blue	Grey	long.	transv.	PVC	PU	PVC	PU		
	K6	K6 U	6 x 3	60	70	✓		✓	✓			40	40	30	35	30	30	Profiles mainly fitted on conveyor belts as guides.
	K6 TR	-	6 x 3	60	-	✓				✓		40	40	25	-	30	-	
	K8	K8 U	8 x 5	60	70	✓	✓	✓	✓			40	40	40	50	40	50	
	K8 TR	-	8 x 5	60	-	✓	✓			✓		40	40	30	-	40	-	
	K10	K10 U	10 x 6	60	70	✓	✓	✓	✓			40	40	60	65	50	50	
	K10 TR	-	10 x 6	60	-	✓	✓			✓		40	40	50	-	50	-	
	K13	K13 U	13 x 8	60	70	✓	✓	✓	✓			45	45	80	85	80	80	
	K13 TR	-	13 x 8	60	-	✓	✓			✓		45	45	70	-	80	-	
	K17	K17 U	17 x 11	60	70	✓	✓	✓	✓			45	45	120	125	100	120	
	K17 TR	-	17 x 11	60	-	✓	✓			✓		45	45	120	-	100	-	
K30	-	30 x 15	60	-	✓		✓	✓			60	60	220	-	150	-		
	KN8	KN8 U	8 x 5	60	70	✓	✓	✓	✓			40	40	35	40	-	-	Knotched profiles can be used on smaller roller diameters.
	KN8 GR	-	8 x 5	60	-	✓				✓		40	40	35	-	-	-	
	KN10	KN10 U	10 x 6	60	70	✓	✓	✓	✓			40	40	40	50	-	-	
	KN10 GR, blue	-	10 x 6	60	-	✓				✓	✓	40	40	40	-	-	-	
	KN13	KN13 U	13 x 8	60	70	✓	✓	✓	✓			45	45	50	60	-	-	
	KN13 GR	-	13 x 8	60	-	✓				✓		45	45	50	-	-	-	
	KN17	KN17 U	17 x 11	60	70	✓	✓	✓	✓			45	45	100	120	-	-	
KN30	-	30 x 15	60	-	✓		✓	✓			60	60	180	-	-	-		
	S8	S8 U	8 x 8	60	70	✓	✓	✓	✓			40	40	80	70	50	50	Profiles fitted transversally or longitudinally.
	S12	S12 U	12 x 12	60	70	✓	✓	✓	✓			45	45	120	100	80	80	
	S15	-	15 x 20	60	-		✓	✓	✓			60	60	220	-	100	-	
	S20	-	20 x 15	60	-		✓	✓	✓			60	60	220	-	130	-	
	S25	-	20 x 25	60	-		✓	✓				60	60	300	-	150	-	
	-	L20 U HP	10 x 20	-	70	✓		✓	✓			-	40	-	-	-	40	PU HP, hardness 70 Sh.A, inclined lateral profiles with highly flexible.
	-	L30 U HP	10 x 30	-	70	✓		✓	✓			-	40	-	-	-	40	
	-	L40 U HP	10 x 40	-	70	✓		✓	✓			-	40	-	-	-	40	
	-	L50 U HP	10 x 50	-	70	✓		✓	✓			-	40	-	-	-	40	
	-	L80 U HP	10 x 80	-	70	✓		✓	✓			-	40	-	-	-	40	
	-	T20 U HP	10 x 20	-	70	✓		✓	✓			-	40	-	-	-	40	PU HP, hardness 70 Sh.A, lateral profiles, with highly flexible.
	-	T30 U HP	10 x 30	-	70	✓		✓	✓			-	40	-	-	-	40	
	-	T40 U HP	10 x 40	-	70	✓		✓	✓			-	40	-	-	-	40	
	-	T50 U HP	10 x 50	-	70	✓		✓	✓			-	40	-	-	-	40	
	-	T60 U HP	10 x 60	-	70	✓		✓	✓			-	40	-	-	-	40	
	-	L20 U	20 x 20	-	85	✓		✓	✓			-	45	-	-	-	60	Polyurethane inclined lateral profiles.
	-	L30 U	20 x 30	-	85	✓		✓	✓			-	45	-	-	-	60	
	-	L40 U	20 x 40	-	85	✓		✓	✓			-	45	-	-	-	60	
	-	L50 U	20 x 50	-	85	✓		✓	✓			-	45	-	-	-	60	
	-	L80 U	20 x 80	-	85	✓		✓	✓			-	45	-	-	-	60	
	-	T20 U	20 x 20	-	85	✓		✓	✓			-	45	-	-	-	60	Polyurethane, lateral profiles, straight.
	-	T30 U	20 x 30	-	85	✓		✓	✓			-	45	-	-	-	60	
	-	T40 U	20 x 40	-	85	✓		✓	✓			-	45	-	-	-	60	
	-	T50 U	20 x 50	-	85	✓		✓	✓			-	45	-	-	-	60	
	-	T60 U	20 x 60	-	85	✓		✓	✓			-	45	-	-	-	60	
	L20	-	23 x 20	60	-		✓	✓	✓			-	55	-	-	80	-	PVC inclined lateral profiles.
	L30	-	23 x 30	60	-		✓	✓	✓			-	55	-	-	80	-	
	L40	-	23 x 40	60	-		✓	✓	✓			-	55	-	-	80	-	
	L50	-	27 x 50	60	-		✓	✓	✓			-	55	-	-	100	-	
	L60	-	27 x 60	60	-		✓	✓	✓			-	55	-	-	100	-	
	L70	-	27 x 70	60	-		✓	✓	✓			-	55	-	-	100	-	
	L80	-	27 x 80	60	-		✓	✓	✓			-	55	-	-	100	-	
	T20	-	23 x 20	60	-		✓	✓	✓			-	55	-	-	80	-	PVC lateral profiles, straight.
	T30	-	23 x 30	60	-		✓	✓	✓			-	55	-	-	80	-	
	T40	-	23 x 40	60	-		✓	✓	✓			-	55	-	-	80	-	
	T50	-	27 x 50	60	-		✓	✓	✓			-	55	-	-	100	-	
	T60	-	27 x 60	60	-		✓	✓	✓			-	55	-	-	100	-	
	T70	-	27 x 70	60	-		✓	✓	✓			-	55	-	-	100	-	
	T80	-	27 x 80	60	-		✓	✓	✓			-	55	-	-	100	-	
	L20 RF	-	20 x 20	60	-	✓		✓	✓			-	50	-	-	80	-	PVC inclined lateral profiles, flat base without groove.
	L30 RF	-	20 x 30	60	-	✓		✓	✓			-	50	-	-	80	-	
	L40 RF	-	20 x 40	60	-	✓		✓	✓			-	50	-	-	80	-	
	L50 RF	-	20 x 50	60	-	✓		✓	✓			-	50	-	-	80	-	
	L70 RF	-	20 x 70	60	-	✓		✓	✓			-	50	-	-	80	-	
	T20 RF	-	20 x 20	60	-	✓		✓	✓			-	50	-	-	80	-	PVC lateral profiles, straight flat base without groove
	T30 RF	-	20 x 30	60	-	✓		✓	✓			-	50	-	-	80	-	
	T40 RF	-	20 x 40	60	-	✓		✓	✓			-	50	-	-	80	-	
	T50 RF	-	20 x 50	60	-	✓		✓	✓			-	50	-	-	80	-	
	T60 RF	-	20 x 60	60	-	✓		✓	✓			-	50	-	-	80	-	
T80 RF	-	20 x 80	60	-	✓		✓	✓			-	50	-	-	80	-		

(1) Minimum pulley diameters referred to environment conditions of 20°C.

Special applications

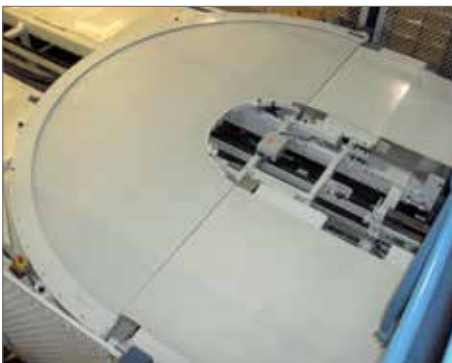

Curve belts

CHIORINO manufactures curve belts suitable for installation on any type of powered curve conveyor existing in the market.

Through a sophisticated totally computer-based (CAD controlled) cutting table, CHIORINO belts can be manufactured without any limitation in the external radius and angle, from a few degrees up to a complete circle (360°). Thanks to this innovative cutting system, CHIORINO curve belts can be supplied on demand for any dimensional requirement and in accordance with customized drawings, ensuring absolute precision and correct working on the conveyor.

The wide range of CHIORINO belts suitable for powered curve conveyors satisfies any application request in airport handling and sorting systems.

On request the curve belts can be fabricated with special finishing such as:

- perforations
- application of buttons
- application of eyelets.

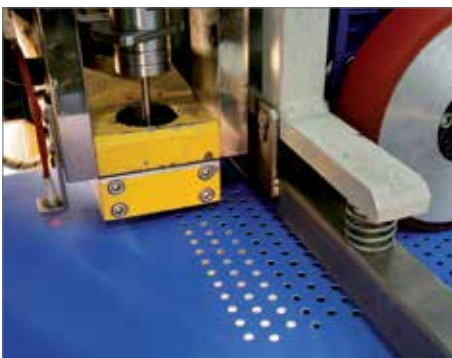

Perforated belts

CHIORINO belts can be perforated according to customized drawings. This procedure is performed so that belts have air suction to prevent the conveyed material from moving around; it is also carried out to allow cooling air to pass through.

Sealed edges

PRO CHLEAN™

This is a procedure performed to protect the edges of CHIORINO belts.

The edge is protected to insulate the fabric structure from the infiltration of conveyed material in order to ensure a longer wear of the belt and to comply with standards on hygiene and with the HACCP concept.



Corrugated profiles

These are applied with a special procedure on PVC or polyurethane belts used to convey fruit.

The special configuration of the profile deadens the impact of the conveyed product and prevents it from becoming bruised. The flexing of the profile during running allows the use of smaller diameter drums.



Finger profiles

These are applied with a special procedure on PVC-W belts used in the fruit and vegetable industry on grading and sorting plants. They are made with a special compound resistant to low temperatures. The finger height is either 100 or 130 mm. With the 130 mm size the fingers are jointed by a reinforcement which limits flexing caused by the weight of the products.



Guide buttons

In special instances when the belt must be kept perfectly in place, PVC or polyurethane guides can be replaced with excellent results by buttons. These buttons allow drums with smaller diameters to be used. Made of plastic, they are smooth-running and wear-resistant; they are riveted on the belt, on one or on both edges.

At least three buttons must be in contact with the drum (fig. 2). Consequently the pitch between buttons will be determined by the roller diameter.

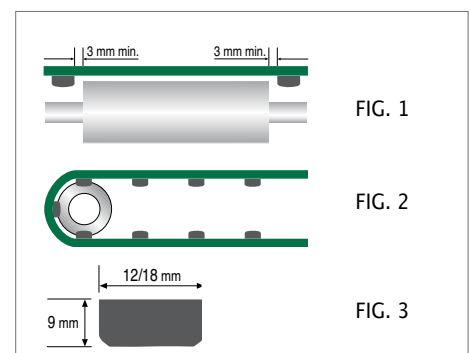

Flat transmission belts

CHIORINO manufactures from raw materials a wide range of high duty transmission belts with excellent resistance to temperature, oils, dust and abrasion.

They are widely used as live roller drives, tangential drives, power transmission drives crossed or multiple, for low, medium and high power, as machine feeding belts and process belts in the paper and folding industry. In particular the main applications are in:

- ▶ **graphic industry**
- ▶ **carton box folding industry**
- ▶ **textile industry**
- ▶ **packaging and confectionary**
- ▶ **mechanical constructions**
- ▶ **wood industry**
- ▶ **flour mills**
- ▶ **marble and tiles industry**



The endless making

CHIORINO is able to perform all necessary operations in its highly automated workshops including cutting, skiving and glueing, punching for the fabrication of endless belt manufacture.

Special transmission belts can also be manufactured complete with:

- ▶ **guides, profiles and sidewalls fitted by means of high frequency and hot air welding machines**
- ▶ **perforations**

Belts can be supplied endless spliced or with prepared ends for on-site splicing, to be done with dedicated solutions and CHIORINO designed equipment.

For the glueing of its transmission belts CHIORINO supplies special cement kits complete with directions for use.

The polyester belts can be made endless without use of cements in a very short time with the CHIORINO Fast Joint system and equipments (see page 24).

The range

Thermoplastic transmission belts with traction core in POLYESTER and elastomer covering.

- ▶ **T-E series:** particularly suitable as tangential drive belts in the textile industry or as power transmission or live roller drives in any other industry (e.g. in the paper and tissue processing industry, the wood industry etc.).
- ▶ **DG-E HS series:** suitable for folder-glueurs in the cardboard industry, as an alternative to the traditional nylon belts of the DG HS series.

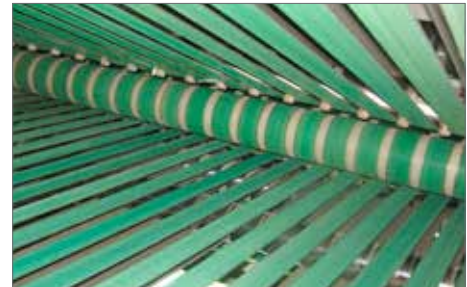

Transmission belts with traction core in POLYAMIDE.

- ▶ **T series:** specially designed for tangential drives in the textile industry. The high-quality features are: rectilinear and quiet running, antistatic, optimum grip, energy saving, resistance to abrasion, heat, oil, dust, are obtained in every field. Suitable for multiple drives. The **T-T series yellow-black** provide straight running and dimensional stability to an outstanding degree. The OE type is specially designed to suit the newest open-end spinning frames.
- ▶ **DG HS series:** these double rubber faced belts have special elastomers which maintain continuous frictional values. Antistatic. Suitable for: folder-gluer machines, tube winders, post office machinery and in the graphic arts industry, multiple drives, etc.
- ▶ **P series:** suitable for both light and medium drives: power operated tools, auxiliary drives in the textile and mechanical industry, etc. Installed as conveyor belts in the packaging and graphic arts industries. Antistatic.
- ▶ **Z series:** suitable for both medium and high horsepower drives; extremely abrasion resistant; oil, grease proof; antistatic. Designed to perform well in difficult working conditions. Recommended for: pumps, ventilators, mixers, rolling-mills, turbines saws for marble, chippers, etc.
- ▶ **LT series:** belts with chrome leather driving surface. Contrary to belts with synthetical covers, LT belts are recommended for all drives subject to violent over loads since the leather driving surface allows temporary slipping without burning. Suitable for: conic drives, drives with belt-shifters, chippers, crushers, paper mills, etc. Suitable for cross drives.
- ▶ **LL series:** belts with double chrome leather covers. The same characteristics and applications envisaged for the LT series apply also to the LL series. Suitable for multiple drives and cross drives.

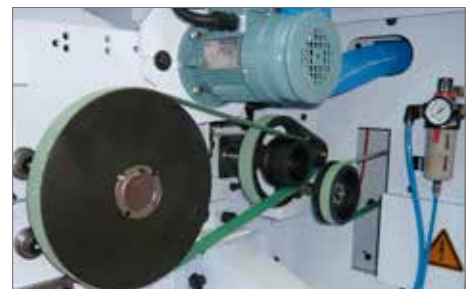

Production program

18

Type	Top surface			Traction core			Driving surface			Total thickness	Weight	Minimum diameter (L)	Pull for 1% elongation	Tensile strength	Temperature resistance
	material	colour	coefficient of friction on steel	material	colour	coefficient of friction on steel	material	colour	coefficient of friction on steel	[mm]	[kg/m ²]	[mm]	[N/mm]	[N/mm]	[°C]

BELTS WITH POLYESTER TRACTION CORE

T20/20E	elastomer	●	0.7	polyester	elastomer	●	0.7	2.2	2.5	25	12.0	180	-20	80
T20/25E	"	●	0.7	"	"	●	0.7	2.5	2.7	40	12.0	180	-20	80
T40/30E	"	●	0.7	"	"	●	0.7	3.0	3.5	50	20.0	250	-20	80
DG-E 10/30 HS	"	●	0.7	"	"	●	0.7	3.0	3.5	30	10.0	180	-20	80
DG-E 10/40 HS	"	●	0.7	"	"	●	0.7	4.0	5.0	40	10.0	180	-20	80
DG-E 10/50 HS	"	●	0.7	"	"	●	0.7	5.0	6.0	60	10.0	180	-20	80
DG-E 10/60 HS	"	●	0.7	"	"	●	0.7	6.0	7.0	60	10.0	180	-20	80

T series

T0	elastomer	●	0.7	polyamide	elastomer	●	0.7	1.4	1.5	20	2.0	80	0	100
T1	"	●	0.7	"	"	●	0.7	1.7	1.8	25	5.0	200	0	100
T1R	"	●	0.7	"	"	●	0.7	2.1	2.3	25	5.0	200	0	100
T2	"	●	0.7	"	"	●	0.7	2.3	2.6	60	7.5	300	0	100
T2R	"	●	0.7	"	"	●	0.7	3.2	3.6	75	7.5	300	0	100
T3	"	●	0.7	"	"	●	0.7	2.6	2.8	100	10.0	400	0	100
T3R	"	●	0.7	"	"	●	0.7	3.4	3.7	100	10.0	400	0	100
T4	"	●	0.7	"	"	●	0.7	3.1	3.4	150	15.0	600	0	100
T4R	"	●	0.7	"	"	●	0.7	3.9	4.5	150	15.0	600	0	100
T4S	"	●	0.7	"	"	●	0.7	5.1	5.9	150	15.0	600	0	100
T1-T	elastomer	●	0.7	polyamide	elastomer	●	0.7	1.8	2.1	25	5.0	200	0	100
T2-T	"	●	0.7	"	"	●	0.7	2.7	3.1	60	7.5	300	0	100
T3-O.E.	"	●	0.7	"	"	●	0.7	2.7	3.0	90	10.0	400	0	100
T3-T	"	●	0.7	"	"	●	0.7	2.9	3.4	100	10.0	400	0	100
T4-T	"	●	0.7	"	"	●	0.7	3.4	3.7	150	15.0	600	0	100

DG HS series

DG1/15 HS	elastomer	●	0.7	polyamide	elastomer	●	0.7	1.6	1.8	20	5.0	200	0	100
DG1/30 HS	"	●	0.7	"	"	●	0.7	3.0	3.4	30	5.0	200	0	100
DG1/40 HS	"	●	0.7	"	"	●	0.7	4.0	4.6	40	5.0	200	0	100
DG2/20 HS	"	●	0.7	"	"	●	0.7	2.4	2.8	40	7.5	300	0	100
DG2/30 HS	"	●	0.7	"	"	●	0.7	3.2	3.7	40	7.5	300	0	100
DG2/40 HS	"	●	0.7	"	"	●	0.7	4.0	4.8	50	7.5	300	0	100
DG2/60 HS	"	●	0.7	"	"	●	0.7	5.5	6.3	60	7.5	300	0	100

Type	Top surface			Traction core			Driving surface			Total thickness	Weight	Minimum diameter (L)	Pull for 1% elongation	Tensile strenght	Max. temperature resistance
	material	colour	coefficient of friction on steel	material	colour	coefficient of friction on steel	material	colour	coefficient of friction on steel	[mm]	[kg/m ²]	[mm]	[N/mm]	[N/mm]	[°C]

P series

P0	polyurethane	●	0.3	polyamide	elastomer	●	0.6	0.9	1.0	15	2.0	80	0	100
PRO	“	●	0.3	“	polyurethane	●	0.3	1.0	1.1	20	3.0	120	0	100
P1	“	●	0.3	“	elastomer	●	0.6	1.4	1.5	25	5.0	200	0	100
P2	“	●	0.3	“	“	●	0.6	2.1	2.3	50	7.5	300	0	100

Z series

Z1	polyurethane	●	0.3	polyamide	elastomer	●	0.6	1.4	1.5	25	5.0	200	0	100
Z2	“	●	0.3	“	“	●	0.6	2.3	2.8	60	7.5	300	0	100
Z3	“	●	0.3	“	“	●	0.6	2.6	3.1	100	10.0	400	0	100
Z4	“	●	0.3	“	“	●	0.6	3.4	3.9	150	15.0	600	0	100
Z6	“	●	0.3	“	“	●	0.6	3.7	4.2	200	20.0	800	0	100
Z9	“	●	0.3	“	“	●	0.6	4.9	5.8	300	30.0	1200	0	100
Z12	“	●	0.3	“	“	●	0.6	5.6	6.3	400	40.0	1600	0	100

LT series

LTOR	polyurethane	●	0.3	polyamide	leather	●	0.4	2.4	2.7	30	3.0	120	0	80
LT1	“	●	0.3	“	“	●	0.4	2.5	2.5	50	5.0	200	0	80
LT2	“	●	0.3	“	“	●	0.4	3.1	3.1	75	7.5	300	0	80
LT3	“	●	0.3	“	“	●	0.4	3.3	3.4	100	10.0	400	0	80
LT4	“	●	0.3	“	“	●	0.4	3.8	4.0	150	15.0	600	0	80
LT6	“	●	0.3	“	“	●	0.4	4.4	4.6	200	20.0	800	0	80
LT9	“	●	0.3	“	“	●	0.4	5.6	5.9	300	30.0	1200	0	80
LT12	“	●	0.3	“	“	●	0.4	6.1	6.8	400	40.0	1600	0	80

LL series

LL0 L	leather	●	0.4	polyamide	leather	●	0.4	3.2	3.2	50	2.0	80	0	80
LL1	“	●	0.4	“	“	●	0.4	3.2	3.2	50	5.0	200	0	80
LL2	“	●	0.4	“	“	●	0.4	4.0	4.1	75	7.5	300	0	80
LL3	“	●	0.4	“	“	●	0.4	4.2	4.4	100	10.0	400	0	80
LL4	“	●	0.4	“	“	●	0.4	4.8	5.0	150	15.0	600	0	80
LL6	“	●	0.4	“	“	●	0.4	6.0	6.0	200	20.0	800	0	80
LL9	“	●	0.4	“	“	●	0.4	7.2	7.6	300	30.0	1200	0	80

(1) The above mentioned values depend on the running speed.

The data of this table has been formulated under normal environment conditions. They are subject to alteration without notice.

Flat belts structure

Top surface	P, PR, Z, LT	Polyurethane	
	T-E, DG-E HS, T, DG HS	Elastomer	
	LL	Leather	
Traction core	P, PR, Z, T, DG HS, LT, LL	class 0÷6 class 9÷12	Mono ply polyamide Double ply polyamide
	T-E, DG-E HS		Polyester fabric
Driving surface	PR	Polyurethane	
	T-E, DG-E HS, P, Z, T, DG HS	Elastomer	
	LT, LL	Leather	

Asymmetric

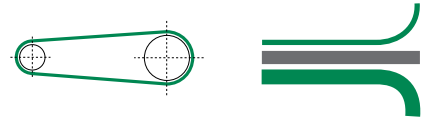

Symmetric

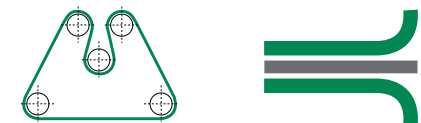

Rolls sizes

The maximum production width of the transmission belts is 500 mm.

Maximum rolls' length (narrower, shorter, longer rolls can be supplied upon request):

PR, P, Z, T, DG HS	120 m approx.	LT 0÷6, LL 0÷4	120 m approx.	T-E, DG-E HS, LT 9÷12, LL 6÷9	60 m approx.
--------------------	---------------	----------------	---------------	-------------------------------	--------------

Endless belts tolerances

Width [mm]	< 60	± 1
	60 ÷ 150	± 1,5
	> 150	± 2

Length [mm]	< 5.000	± 0,5%
	5.000 ÷ 20.000	± 0,3%
	> 20.000	± 0,2 %

Configuration of the pulleys

To assist tracking of the belt it is advisable to crown the drive pulley. When considering drives with minimal difference between the pulleys' diameters or with vertical or semi-crossed drives, it is advisable to also crown the smaller pulley, decreasing the h value by half. With multiple pulley drives, the pulleys to be crowned are only those touched by the same face of the belt. It is important to crown the pulley (s) as shown in the figure below. Do not fit pointed or truncated cone-shaped pulleys. Materials recommended: cast iron or steel with smooth surface finish. The dimension h is a value of the pulley diameter up to 400 mm (see table 1). For $\varnothing \geq 400$ mm, h is a value of the diameter \varnothing , as well as the face width b of the pulley (see table 2). Usually the belt width recommended is as a minimum 10 mm narrower than the pulley face width.

TAB. 1
Dimensions for pulleys having diameter D from 40 to 355 mm (ISO R 22/DIN 111)

Diameter D	Dimension h max
from 40 to 112	0,3
125 and 140	0.4
160 and 180	0.5
200 and 224	0.6
250 and 280	0.8
315 and 355	1.0

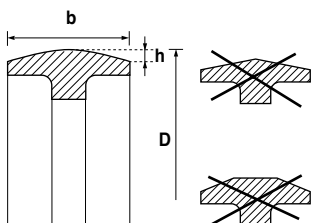

TAB. 2
Dimensions for pulleys having diameter D from 400 to 2000 mm (ISO R 22 / DIN 111)

Width b	≤125	140 and 160	180 and 200	224 and 250	280 and 315	355	≥400
Diameter D	Dimension h max						
400	1.0	1.2	1.2	1.2	1.2	1.2	1.2
459	1.0	1.2	1.2	1.2	1.2	1.2	1.2
500	1.0	1.5	1.5	1.5	1.5	1.5	1.5
560	1.0	1.5	1.5	1.5	1.5	1.5	1.5
630	1.0	1.5	2.0	2.0	2.0	2.0	2.0
710	1.0	1.5	2.0	2.0	2.0	2.0	2.0
800	1.0	1.5	2.0	2.5	2.5	2.5	2.5
900	1.0	1.5	2.0	2.5	2.5	2.5	2.5
1000	1.0	1.5	2.0	2.5	3.0	3.0	3.0
1120	1.2	1.5	2.0	2.5	3.0	3.0	3.5
1250	1.2	1.5	2.0	2.5	3.0	3.5	4.0
1400	1.5	2.0	2.5	3.0	3.5	4.0	4.0
1600	1.5	2.0	2.5	3.0	3.5	4.0	5.0
1800	2.0	2.5	3.0	3.5	4.0	5.0	5.0
2000	2.0	2.5	3.0	3.5	4.0	5.0	6.0

Polyurethane round and V-belts

CHIORINO manufactures by extrusion both polyurethane round and V Section belts which are used in various markets for transmission of light duty drives, at medium low speeds and conveying light loads.

Main characteristics: extremely good tensile strengths, elasticity and flexibility values; very high resistance to abrasion, tearing, grease and pure mineral oils, petrols and hydrolisis. The recommended working temperatures is between -20 and +60 C degrees.

Round belting is now available in two versions:

- "RU HP" series in blue color with smooth surface, complying to EU regulations EC 1935/2004, EC 2023/2006, EU 10/2011 and FDA, 85 Sh.A hardness;
- "RU" series in green colour with rough surface, 92 Sh.A hardness.

The V-belts are manufactured in a single range which has a smooth surface, 92 Sh.A hardness, in bright green colour.

Fast Joint

Being thermoweldable polyurethane it enables quick endless jointing of belts. For high precision joints of round and V-belts of any size CHIORINO supply the **FAST JOINT welder "S15"** - see photo and page 26.

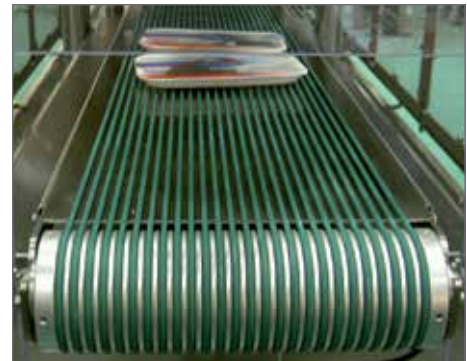

Belts diameter [mm]	Nominal transmission power (kW) Tension 8%				Pull for 8% elongation [N]	Min. pulley's diameter [mm]
	speed [m/sec]					
	2.5	5	10	15		
2	0.01	0.02	0.04	0.06	8	15
3	0.02	0.05	0.07	0.12	18	20
4	0.04	0.08	0.16	0.23	30	35
5	0.06	0.13	0.25	0.37	50	45
6	0.09	0.18	0.36	0.50	70	50
7	0.12	0.25	0.50	0.75	100	60
8	0.17	0.35	0.70	0.90	130	70
9	0.20	0.40	0.85	1.12	160	75
10	0.27	0.55	1.05	1.50	200	80
12	0.40	0.80	1.50	2.00	280	100
15	0.58	1.15	2.00	3.30	440	130

	Type	Section b x h [mm]	Pull for 8% elongation [N]	Min. pulley's diameter [mm]
	L	8 x 5	16	40
Z	10 x 6	28	50	
A	13 x 8	45	60	
B	17 x 11	62	75	
C	22 x 14	105	100	

The data of these tables has been formulated under normal environment conditions. They are subject to alteration without notice.

Equipment and jointing systems



The **ENGINEERING DIVISION** of CHIORINO designs and supplies equipment for making endless conveyor and transmission belts. This booklet illustrates **LIGHTWEIGHT EQUIPMENT** and equipment suitable for **JOINTING ON SITE**, which are available ex-stock.

All the above equipment can be supplied either with 220 or 380 V and 50 or 60 Hz frequency. Every machine complies with the CE european directives and it is complete with the operating and maintenance instructions.

CHIORINO can also supply for the **PROFESSIONAL WORKSHOPS**:

- ▶ **cutting benches**
- ▶ **cutting and slitting machines**
- ▶ **skiving machines and splitting machines (lappers)**
- ▶ **punching machines and workshop presses**
- ▶ **hot-air welders and high frequency machines for applying profiles and guides.**

CHIORINO offers a wide choice of jointing systems, designed to match all the application needs. In the next page are summarised the types of joints that can be selected to make CHIORINO belts endless. All the the jointing systems described must be related to the belt type and the working conditions.

CHIORINO operates internationally through a widespread distribution and services network which provides the best applications and solutions for every sector as well as a fast service.

The CHIORINO technical service can solve any problem of product handling; highly specialized teams are available to perform on-site installations, offering the customer a truly global service.

Conveyor and transmission belts jointing systems

▶ OVERLAP

This system is applicable to thermoplastic polyurethane belts (photo 1).

▶ FINGER JOINTS

Traditional splicing method that guarantees thickness and alignment evenness.

- **MICRO Z:** fast joint for conveyor and transmission belts (photo 2).
- **SINGLE Z:** it offers the maximum of flexibility. Ideal on fixed knife edges. Seam sealing foil can be used to increase strength and for heavy applications (photo 3).
- **DOUBLE Z:** it provides high strength and can be used in alternative to single Z (photo 4).

▶ SKIVED

Special method for polyamide transmission belts and some conveyor belts for special applications as alternative to the traditional finger joints (photo 5).

▶ STEP

Special method for some belts and for special applications as alternative to the traditional finger joints (photo 6).

▶ PLASTIC FASTENER

Non metallic fastener made of polyester fabric and spirallace. It has a high resistance to chemicals, guarantees flexibility and a short replacement time. It is FDA approved. It is suitable for over 16 mm diameter pulleys and in particular in those applications involving X-Ray scanners or metal detectors (photo 7).

▶ METAL FASTENERS

Mechanical fasteners suitable in those situations where ease and speed of fitting is required. They are available both in galvanized and stainless steel, in the following types:

- **M/G:** suitable for every belt type, in particular for airport systems, for food industry and for textile industry (photo 8).
- **M/M:** suitable for every belt type and application. They do not need equipment for their application (photo 9).
- **M/SL:** suitable for every belt type and application (photo 10).
- **M/SW:** suitable for belts thicker than 2 mm. They guarantee superior strength. They are in particular used in the agricultural industry (photo 11).

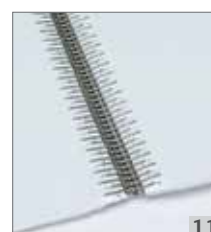
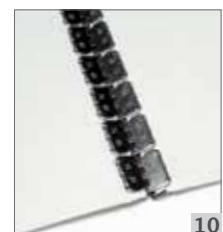
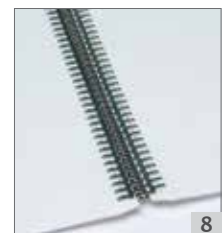

Fast Joint equipment



3 min.

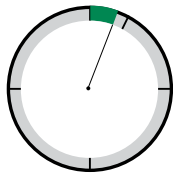

CHIORINO has designed fast and easy to make jointing systems obtained by using purpose designed equipment.

Features of the CHIORINO Fast Joint systems:

- ▶ they can be executed on thermoplastic conveyor and transmission belts
- ▶ no use of cements
- ▶ they guarantee ease of use and speed of execution: a few minutes, using the equipment here shown and following the jointing procedures ensuring quality joints.



CHIORINO FAST JOINT KIT

With the Fast Joint Kit CHIORINO thermoplastic conveyor and transmission belts can be made endless in a few minutes without the use of adhesives **in just four steps**:

- ▶ 1: place the belt with prepared ends on the holding plate,
- ▶ 2: cover with the appropriate plate and fasten with the fastening clamps,
- ▶ 3: press according to the times recommended in the operating manual,
- ▶ 4: remove press and replace with cold clamp for cooling.



Type	Description	Plates' sizes wxl [mm]	Weight [kg]
P50 FJ	Press with 2 heated platens, suitable for endless making of CHIORINO thermoplastic conveyor and transmission belts, up to 40 mm wide and a maximum of 3 mm thickness. It is supplied along with 2 holding plates with fixed width (20 and 25 mm), 2 clamps for belt fastening and 1 cooling clamp.	50x50	1,4

	Description	Dimensions wxlh [mm]	Weight [kg]
F35 M	Hand-operated puncher for MICRO-Z fingers of thermoplastic conveyor and transmission belts, up to 120 mm wide and a maximum of 4 mm thickness.	220x215x130	1,3



Type	Description	Dimensions wxlh [mm]	Weight [kg]
F80 ME	Hand-operated puncher for SINGLE-Z fingers of conveyor and transmission belts, up to 80 mm wide and a maximum of 6 mm thickness.	640x200x350	14



Type	Description	Dimensions wxlh [mm]	Weight [kg]
P120 FJ	Press with two heated platens, suitable for endless making of thermoplastic materials up to 80 mm wide and a maximum of 6 mm thickness. It can be supplied in a kit, along with holding plates, fastening and cooling clamps.	330x155x130	4
		Plates' sizes wxl [mm] 100x140	



Type	Description	Dimensions wxlh [mm]	Weight [kg]
EL250	Type EL250 Press with 2 heated platens, suitable for endless making of thermoplastic polyurethane elastic belts (EL series) up to 200 mm wide and a maximum of 2 mm thickness.	400x140x200	17
		Plates' sizes wxl [mm] 230x25	



Punchers, skivers, welders



Type	Description	Dimensions wxlxh [mm]	Weight [kg]
F700 M	Hydraulic hand operated puncher, for SINGLE Z fingers on belts up to a maximum of 5,5 mm thickness.	820x380x340	30



Type	Description	Dimensions wxlxh [mm]	Weight [kg]
B80 D	Hand operated plate skiver for conveyor and transmission belts up to 80 mm wide and a maximum of 1,3 mm thickness.	320x250x250	5



Type	Description	Dimensions wxlxh [mm]	Weight [kg]
B100 R	Roller skiver without motor (B100 R) or with motor (B100 RM) for conveyor and transmission belts up to 100 mm wide with 90° straight cut and a maximum of 5 mm thickness.	330x260x170	8,5
B100 RM		570x260x250	25



Type	Description	Dimensions wxlxh [mm]	Weight [kg]
B300 SA	Skiver ideal to obtain accurate skives with preset angle on belts and belting up to 300 mm wide with 90° straight cut and max. thickness 10 mm.	550x600x450	42



Type	Description	Dimensions wxlxh [mm]	Weight [kg]
S15	Fast Joint welder for jointing PU round and V-belts. It can be supplied with clamp and pliers.	160x90x110	3

Presses for vulcanizing skived conveyor and transmission belts

Type	Description	Dimensions wxlh [mm]	Max. temp. [°C]	Weight [kg]
P100 K	Press for vulcanizing skived conveyor and transmission belts up to 100 mm wide and a maximum of 5,5 mm thickness.	300x145x140	135	2
		Plates' sizes wxl [mm] 120x105		



P100 K

Type	Description	Dimensions wxlh [mm]	Max. temp. [°C]	Weight [kg]
P200	Press for vulcanizing skived polyurethane and PVC conveyor and transmission belts up to 200 mm wide and a maximum of 10 mm thickness.	350x210x190	135	11
		Plates' sizes wxl [mm] 220x160		

P200

Presses with cooling system for thermoplastic and thermosetting belts

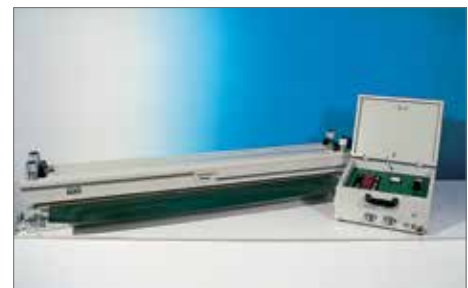
Type	Dimensions wxlh [mm]	Plates' sizes wxl [mm]	Max. width [mm]	Max. temp. [°C]	Weight [kg]
P300 L	640x230x210	430x150	300	185	24
P400 L	740x230x210	530x150	400	185	28
P600 L	940x230x210	730x150	600	185	36
P800 L	1140x230x250	930x150	800	185	50
P1000 L	1340x230x270	1130x150	1000	185	65
P1200 L	1690x225x290	1360x150	1200	185	101
P1600 L	2090x225x310	1760x150	1600	185	131
P2200 L	2540x235x385	2360x150	2200	185	196
P2600 L	2940x235x480	2760x150	2600	185	260
P3000 L	3360x235x580	3160x150	3000	185	340
P3400 L	3760x235x640	3560x150	3400	185	390
P400 L S	800x250x350	530x100	400	185	25
P600 L S	950x250x350	730x100	600	185	31
P800 L S	1150x250x350	930x100	800	185	39

P300-1000 L

P1200-3400 L

P400-800 LS

“Texgum” roller coverings

“Texgum” roller coverings are designed to increase the coefficient of friction of rollers and are used mainly in the weaving and finishing sectors of the Textile industry. They are manufactured to the highest possible standards using specially designed elastomers.

The comprehensive range is suitable for all types of machinery and offers technical qualities such as:

- ▶ high quality textile carcass with very good dimensional stability even for wet processing;
- ▶ high wear resistant covers in natural rubber, specially formulated elastomers and silicones;
- ▶ consistent quality due to the fully automated cycle of production control.

Features

- ▶ **Textile carcass:** polyester fabric, except for the FG types (fiberglass), FLO (non woven).
- ▶ **Self-adhesive version (/A):** can be supplied for all types, except for S10-FG, S12-FG.
- ▶ **Roll's width:** available in 50 - 70 mm. Other widths upon request.



Recommendations for fitting

Clean rollers thoroughly by means of non oily solvent. To wrap the roller covering spiral-wise, cut the end of the covering aslant by a length equal to the circumference of the roller. Apply the adhesive first to the roller and then to the Texgum covering and wrap the latter while it is still slightly tacky. The silicone adhesive must be applied to the roller only, taking care to wrap the covering on the roller immediately. Then fix the ends of the covering by means of an adhesive tape. Wait for 8 hours before use.

Adhesives

- ▶ **Texcol:** for all types, except S10-FG.
- ▶ **Silicone:** for S10-FG.

Type	Covering		hardness Sh.A	Thickness mm	Weight Kg/m ²	Temperature resistance		Rolls' length m
	material	colour				min.	max.	
NG0	Natural elastomer	●	50	1.5	1.6	0	100	100
NG3		●	50	2.0	2.2	0	100	100
NG5		●	50	1.9	2.1	0	100	100
NG7		●	50	1.7	1.9	0	100	115
NG7-S		●	50	2.5	2.6	0	100	115
NG8		●	55	2.0	2.0	0	100	100
SG0	Synthetic elastomer	●	55	1.8	2.1	-10	120	115
SG0-D		●	75	2.3	2.1	-10	120	115
SG0-E		●	50	2.7	2.2	-10	120	115
SG0-E nc		●	50	2.7	2.2	-10	120	115
SG0-M		●	50	2.2	2.3	-10	120	115
SG0-S		●	55	2.5	2.6	-10	120	115
SG1		●	55	2.0	2.6	-10	120	115
SG1-E		●	40	3.0	2.3	-10	120	115
SG3		●	65	2.0	2.2	-10	120	100
SG4		●	50	4.2	2.9	-10	120	100
SG5		●	65	2.0	1.8	-10	120	100
SG6		●	65	2.0	2.3	-10	120	100
SG7		○	65	2.0	2.2	-10	120	115
SG7 gr		●	65	2.0	2.2	-10	120	115
SG7-H		●	65	2.0	2.2	-10	120	115
SG7-L		○	65	1.7	2.0	-10	120	115
SG7-M		●	50	1.9	1.3	-10	120	115
SG7-S		○	65	2.5	2.9	-10	120	115
SG8		●	60	2.0	2.1	-10	120	100
SG8 HX		●	50	2.5	2.1	-10	120	100
PV0	PVC	⊗	45	1.8	2.0	0	60	100
PV0 ve		●	45	1.8	2.0	0	60	100
PV5		⊗	45	2.3	2.4	0	60	100
PV5 ve		●	45	2.3	2.4	0	60	100
PV6		⊗	45	1.9	2.0	0	60	100
PV6 ve		●	45	1.9	2.0	0	60	100
PV7		⊗	45	1.9	2.0	0	60	100
PV7 ve		●	45	1.9	2.0	0	60	100
SI0	Silicone	○	50	1.1	1.0	-20	160	115
SI0-FG		○	50	1.4	1.3	-50	200	115
SI0-S		○	50	2.0	2.1	-20	160	115
SI1 az		●	45	1.6	1.7	-20	150	115
SI2-FG		⊗	50	1.5	1.4	-50	200	115
NP0/A	Neoprene	●	---	3.5	0.7	-40	70	50
FLO	Velvet	●	---	2.4	0.8	-10	60	50

SG Type of covering

O Surface pattern

M Special execution

TYPE OF COVERING

FLO Velvet

NG Natural elastomer

NP Neoprene

PV PVC

SG Synthetic elastomer

SI Silicone

SURFACE PATTERNS

0 Smooth

1 Light fabric

2 Medium fabric

3 Heavy fabric

4 Grip face

5 Pimpled

6 Fine sandblast

7 Medium sandblast

8 Heavy sandblast

SPECIAL EXECUTIONS

D High shore hardness

E Foam synthetic elastomer

FG Fiberglass textile carcass

H High performance

HX High performing carboxylic elastomer

L Less rubber

M Soft

S Extra rubber

The data of this table has been formulated under normal environment conditions. They are subject to alteration without notice.

Endless rubber mandril made belts

CHIORINO manufactures a wide range of MF elastomer belts suitable for applications in various industrial sectors (carton folding industry, packaging, post office automation etc.).

Main features of "MF" CHIORINO endless belts:

- ▶ **no joint:** manufactured with endless technology which guarantees endless uniformity of the surface and the coefficient of friction
- ▶ **absolute thickness regularity**
- ▶ **perfect dimensional stability** due to the polyester fabric core

The **elastomer covering** which keeps its original working surface during the whole working life is available in the following colour and hardness range dependent on the coefficient of friction required on application:

B = beige, 50 Sh.A



HS = white, 40 Sh.A

L = raspberry, 35 Sh.A

R = purple red, 45 Sh.A

Tooth belts can be applied to the bottom surface to provide absolute synchronous drive where required avoiding any risk of slippage. The toothed belt can be in elastomer (metric and imperial pitch) or in polyurethane (metric pitch). Other special constructions including punched holes where air suction units are fitted can be manufactured on request.

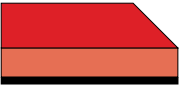
BELTS CONSTRUCTION

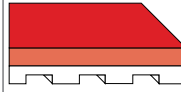
			
Elastic belt (without fabric core)	Belt with polyester fabric core	For synchronous drive metric or imperial pitch timing belt base in elastomer	For synchronous drive metric timing belt base in polyurethane
Two elastomer layers: - feedside, high coefficient of friction, is available in the colours and hardnesses stated above; - black driveside, hard-wearing.	Composition: - feedside, high coefficient of friction, is available in the colours and hardnesses stated above; - fabric core; - natural colour driveside, hard-wearing and low coefficient of friction	Timing belts designed for synchronous drive in both metric and imperial pitch. The high friction coefficient elastomer cover is available in the colours and hardness stated above.	Timing belts designed for synchronous drive in metric pitch. The high friction coefficient elastomer cover is available in the colours and hardness stated above.

Carton folding industry

Truly endless belts used as feeder belts on folder-glueers for smooth and corrugated cardboard. The outer cover made of self-regenerating elastomer maintains the coefficient of friction unchanged. The elastomer inner cover guarantees a consistent feeding even on the fastest machines. The CHIORINO truly endless belts are made without using any rubber latex and for this reason they are suitable for manufacturing boxes in the food and pharmaceutical industries. These belts are available with three different versions of the MF cover to be selected according to the type of material to be processed:

- **L raspberry**: suitable for smooth cardboard, either glossy or matt;
- **R purple red**: suitable for abrasive smooth cardboard, PVC boxes, corrugated cardboard;
- **HS W**: for very abrasive and heavy cardboard and for high speed folder-glueers.

Type	Available thicknesses ⁽¹⁾		Outer cover		Sh.A	Traction core		Inner cover	
	mm	material	colour	Sh.A		material	colour	Sh.A	
MF L-351 G	6 ÷ 12	elastomer	●	35	polyester	elastomer	●	65	
MF R-351 G	"	"	●	45	"	"	●	65	
MF HS W-351 G	"	"	○	40	"	"	●	65	
MF L-300	"	"	●	35	"	---	●	---	
MF R-300	"	"	●	45	"	---	●	---	
MF HS W-300	"	"	○	40	"	---	●	---	

⁽¹⁾ For non-standard thicknesses, please contact the CHIORINO Technical Assistance.

Form-fill-seal belts

CHIORINO have specially developed a range of endless belts for form-fill machines to improve the filling of the packets mainly in the food industry. The packets are gripped and drawn down by two specially constructed belts, usually located vertically for easier filling control of the product with loose products (drops, chips, pasta etc.). Speeds are extremely high ranging from 80 to 150 packets per minute. The MF elastomer covering is available in two different versions of the MF cover according to the type of packaging, in order to get the best ratio of needed friction and surface abrasion resistance.

- **R purple red**: for PVC and polyethylene films; also suitable for abrasive packagings (paper, fabric);
- **B beige**: particularly suitable for abrasive packagings (paper, fabric).

Type	Available thicknesses ⁽¹⁾		Outer cover		Sh.A	Traction core		Inner cover	
	mm	material	colour	Sh.A		material	colour	Sh.A	
MF R-052	5 ÷ 15	elastomer	●	45	---	elastomer	●	45	
MF R-053	"	"	●	45	---	"	●	65	
MF B-300	6 ÷ 12	"	●	50	polyester	---	●	---	
MF R-300	"	"	●	45	"	---	●	---	

⁽¹⁾ For non-standard thicknesses, please contact the CHIORINO Technical Assistance.

The data of these tables has been formulated under normal environment conditions. They are subject to alteration without notice.



Rubber and silicone sheeting

CHIORINO manufactures rolls and sheeting in a wide variety of polymers depending on the type of application:

- ▶ **elastomer** where high flexibility is required
- ▶ **silicone**: for high temperature and non-stick application.

CHIORINO sheeting are manufactured in rolls of max. width 1600 or 2000 mm and standard length of 100/200 m. They can also be supplied cut to size according to customer's requirement.

They are available in hardnesses from 35 to 50 Sh.A and in different colours. They are manufactured in standard thicknesses from 1 to 10 mm; other thicknesses are available on request.

Applications

- ▶ **Furnitures manufacturing**: on veneering presses, for the application of PVC or wood films on shaped panels. Pads perfectly follow the panels' shapes under pressure, transferring the desired temperature during the working cycle. The silicone pad LI SI W can operate at temperatures up to 200° C.
- ▶ **Carton box folding industry**: the sheeting produced by CHIORINO are vulcanised on carcasses to manufacture truly endless feeding belts for box folding machines. The same rubber can be supplied in rolls and used for covering timing or flat belts for the same purpose. They can be supplied with a Sh.A hardness of 35 or 45 degrees to be suitable for any kind of carton, giving high surface friction and excellent wearing properties.
- ▶ **Packaging**: as covering for flat or timing belts automatic bag filling machines.
- ▶ **Leather industry**
- ▶ **Silk screen printing**
- ▶ **Photovoltaic**

CHIORINO sheeting without fabric support are used in a wide range of other industrial sectors: mining and ceramics for material sieving, linings for piping for pumping water and silt from rivers, protective linings for animal cages, window wipers, bullet fragmentation and rebound control in shooting galleries, etc.

The availability of different Shore hardness allows this material to cover a wide range of industry.



Type	Material	Hardness	Colour	Thickness	Weight	Surface pattern		Temperature resistance		Production width
		Sh.A [±5]		mm	Kg/m ²	outer	inner	min.	max.	mm

SHEETING FOR VENEERING PRESSES

LI-G10	elastomer	45	●	1.0	1.1	smooth	FL	-20	120	2000
LI-G20	"	45	●	2.0	2.2			-20	120	2000
LI-G25	"	45	●	2.5	2.7			-20	120	2000
LI-G35	"	45	●	3.5	3.8			-20	120	2000
LI-G40	"	45	●	4.0	4.5			-20	120	2000
LI-G50	"	45	●	5.0	5.3			-20	120	2000
LI-S110	"	40	○	1.0	1.1			-50	160	2000
LI-S120	silicone	40	○	2.0	2.2			-50	160	2000
LI-S130	"	40	○	3.0	3.4			-50	160	2000
LI-S140	"	40	○	4.0	4.6			-50	160	2000
LI-S110 W	"	50	○	1.0	1.1			-50	200	2000
LI-S120 W	"	50	○	2.0	2.2			-50	200	2000
LI-S130 W	"	50	○	3.0	3.3			-50	200	2000
LI-S140 W	"	50	○	4.0	4.4			-50	200	2000

SHEETING FOR CARTON BOX FOLDING INDUSTRY AND PACKAGING

LC-G20 MF-R	elastomer	45	●	2.0	2.2	FL	FL	-20	100	1600
LC-G30 MF-L	"	35	●	3.0	3.0			-30	80	1600
LC-G30 MF-R	"	45	●	3.0	3.3			-20	100	1600
LC-G40 MF-L	"	35	●	4.0	4.0			-30	80	1600
LC-G40 MF-R	"	45	●	4.0	4.4			-20	100	1600
LC-G50 MF-L	"	35	●	5.0	5.0			-30	80	1600
LC-G50 MF-R	"	45	●	5.0	5.5			-20	100	1600
LC-G60 MF-L	"	35	●	6.0	6.0			-30	80	1600
LC-G60 MF-R	"	45	●	6.0	6.6			-20	100	1600
LC-G80 MF-L	"	35	●	8.0	8.0			-30	80	1600
LC-G80 MF-R	"	45	●	8.0	8.8			-20	100	1600
LC-G100 MF-R	"	45	●	10.0	11.0			-20	100	1600

SHEETING FOR LEATHER INDUSTRY

LP-G20 FL	elastomer	45	●	2.0	2.2	FL	FL	-20	120	2000
LP-G25 FL	"	45	●	2.5	2.7			-20	120	2000

SHEETING FOR SILK-SCREEN PRINTING

LX-45-G20	elastomer	45	●	2.0	1.9	FH	FL	-20	100	2000
-----------	-----------	----	---	-----	-----	----	----	-----	-----	------

The data of this table has been formulated under normal environment conditions. They are subject to alteration without notice.

Worldwide network of distribution and sale

34

EUROPE

BENELUX

**CHIORINO BENELUX B.V. – Utrecht,
The Netherlands**
Tel. +31-30-2413060
chiorino@chiorino.nl – www.chiorino.nl

BYELORUSSIA

CHIORINO-K – Minsk
Tel. +375-17-2804578
general@chiorino.ru – www.chiorino.ru

In charge of:

**KAZAKHSTAN
KIRGYZSTAN
MOLDOVA
TAGIKISTAN
TURKMENISTAN
UZBEKISTAN**

RUSSIA: MEGADRIVE LTD – Moscow
Tel. +7-495-3462410

**UKRAINE: UNIBELT LTD
Kotsubinskoje, Kiev**
Tel. +380-45-9772740

CYPRUS

YIAVIS Belts Ltd. – Nicosia
Tel. +357-22-481624
yiavind@spidernet.com.cy

CZECH REPUBLIC and SLOVAK REPUBLIC

REKO s.r.o. – Jaromer
Tel. +420-491-840012
info@reko-sro.cz – www.reko-sro.cz

In charge of Slovak Republic:

QUIRIS s.r.o. – Nimnica
Tel. +421-424-675169
quiris@slovanet.sk – www.quiris.sk

DENMARK

NIELS BURCHARTH A/S – Horsens
Tel. +45-76254100
sales@niels-burcharth.dk
www.niels-burcharth.dk

FINLAND

**SUOMEN EURO – KUMI OY – Etola Group
Pieksamaki** – Tel. +358-15-484311
euro-kumi@euro-kumi.com
www.euro-kumi.com



CHIORINO UK – Featherstone



CHIORINO DEUTSCHLAND – Mainz

FRANCE

CHIORINO SAS – Lagny, Paris
Tel. +33-1-64304075
chiorino.paris@chiorino.fr

Branches:

**AGENCE RHONE-ALPES
Saint-Priest** – Tel. +33-4-78210863
chiorino-lyon@chiorino.fr

AGENCE OUEST

S. Julien De Concelles – Tel. +33-2-40365467
chiorino.grand-ouest@chiorino.fr

AGENCE SUD-OUEST

Villeneuve Sur Lot – Tel. +33-5-53419342
vschiorino@chiorino.fr

AGENCE NORD

Lomme – Tel. +33-3-20240128
sets2@wanadoo.fr – www.sets-france.fr

GERMANY

CHIORINO GmbH – Mainz
Tel. +49-(0)6131-55449-0
info@chiorino.de – www.chiorino.de

HUNGARY

**CHIORINO Kft. – Szigetszentmiklós,
Budapest**
Tel. +36-24-525930
mail@chiorino.hu – www.chiorino.hu

LITHUANIA

UAB NARVIJA – Klaipeda
Tel. +370 46 495925/ 380888
info@narvija.com – www.narvija.lt

In charge of:

**ESTONIA
LATVIA**

POLAND

CHIORINO Sp. z o.o. – Bydgoszcz
Tel. +48-052-3487708
chiorino@chiorino.com.pl
www.chiorino.com.pl

In charge of:

**ARMENIA
AZERBAIGIAN
GEORGIA**

PORTUGAL

**CHIORINO PORTUGAL, LDA
Alfena Valongo, Porto**
Tel. +35-122-9684442
geral@chiorino.pt



CHIORINO FRANCE – Lagny, Paris



CHIORINO BENELUX – Utrecht

ROMANIA

CHIORINO srl – Cluj Napoca
Tel. +40-264 432977
chiorino@chiorino.ro – www.chiorino.ro
Branch:
Bucarest – Tel. +40-21 2301262

SLOVENIA

**KONUS KONEX Ltd.
Slovenske Konjice**
Tel. +386-3-7573100
info@konuskonex.com
www.konuskonex.com

In charge of:

**BOSNIA and HERZEGOVINA
CROATIA
MACEDONIA
SERBIA**

SPAIN

**CHIORINO IBÉRICA S.A.U.
Rubí, Barcelona**
Tel. +34-93-5860480
chiorino@chiorino.es
www.chiorino.es

Branches:

Madrid – Tel. +34-91 615 94 80
madrid@chiorino.es

Valencia – Tel. +34-96-1340751
valencia@chiorino.es

Vitoria – Tel. +34-945-120472
vitoria@chiorino.es

SWEDEN

WENNERLUNDS MASKIN AB – Göteborg
Tel. +46-31-878055
info@wennerlunds.com
www.wennerlunds.com

UNITED KINGDOM and IRELAND

CHIORINO U.K. Ltd. – Featherstone
Tel. +44-1977-691880
sales@chiorino.co.uk
www.chiorino.co.uk

Branches:

**MIDLANDS: Birmingham
Chelmsley Wood**
Tel. +44-121 7793922

SOUTH: Caterham
Tel. +44-1883 336748

NORTH EAST: Cramlington
Tel. +44-1670 713497



CHIORINO ESPAÑA – Rubí, Barcelona



CHIORINO POLAND – Bydgoszcz

AMERICA

ARGENTINA

WARBEL S.A. - Resistencia
Tel. +54-3-722-461500
warbelventas@warbel.com.ar
www.warbel.com.ar

Branches:

Buenos Aires - carlosgarcia@warbel.com.ar
Córdoba - Tel. +54-351-4897224
pedrobolosin@warbel.com.ar
Olavarría - Tel. +54-9-3722-669626
warbelolavarria@infovia.com.ar
Rosario - Tel. +54-3-414389600
sergiogarcia@warbel.com.ar

BRAZIL

CHIORINO LIMITADA - São Paulo
Tel. +55-11-2584-1510
chiorino@chiorino.com.br
www.chiorino.com.br

COLOMBIA

REIMPEX S.A. - Medellín-Itagui
Tel. +57-4-4448805 - info@reimpex.com

Branches:

Bogota - Tel. 57-1-6088181
reimpexbogota@une.net.co
Cali - Fax 572 665 98 65
reimpexcali@une.net.co

MEXICO

INTERBELTING S.A. de C.V. Naucalpan de Juárez
Tel. +52-55-2452 5050
mexico@interbelting.com - www.interbelting.com

Branches:

Monterrey, Nuevo Leon
Tel. +52-81-86764680
monterrey@interbelting.com
Puebla - Tel. +52-22-22207949
puebla@interbelting.com

U.S.A.

CHIORINO INC. - Newark, DE
Tel. +1-302-292-1906
info@chiorino.us - www.chiorino.us

Branch:

SOUTH: Scott, LA - Tel. +1-337-231-5688



CHIORINO ROMANIA - Cluj Napoca



CHIORINO FAR EAST - Singapore

ASIA

CHINA

CHIORINO LIAISON OFFICE Shanghai - Tel. +86-21-37831019
info@chiorino.cn
www.chiorino.cn

INDONESIA

PT PROTECHMA - Cibitung Bekasi
Tel. +62-21-8832 6735
absorbent_ctn@protechma.com
www.protechma.com

ISRAEL

GALPARTS Ltd. - Tel Aviv
Tel. +972-3-5620933
glp@netvision.net.il

SAUDI ARABIA

ARABIAN UNIVERSAL EST. - Jeddah
Tel. +966-2-6477159
info@aue-co.com

Branch:

Riyadh - Tel. +966-1-4383520

SINGAPORE

CHIORINO FAR EAST Pte. Ltd. Singapore
Tel. +65/67426266
sales@chiorino.com.sg
www.chiorino.com.sg

THAILAND

UNITED BELTING COMPANY LTD Bangkok
Tel. 662-8651977
sales@ubbelts.com
www.ubbelts.com

TURKEY

İSÇİMENLER LTD. ŞTİ. - Izmir
Tel. +90-232-8877 00 22
info@iscimenler.com.tr
www.iscimenler.com.tr

Branch:

Istanbul - Tel. +90-212-549 42 34
yasin@iscimenler.com.tr



CHIORINO HUNGARY - Budapest



CHIORINO SOUTH AFRICA - Durban

AFRICA

EGYPT

MAGITEC - Cairo
Tel. +20-2-22683407
magitec2000@mail.com

SOUTH AFRICA

CHIORINO SOUTH AFRICA (PTY) LTD. Durban
Tel. +27-31-7925500
sales@chiorino.co.za
www.chiorino.com

Branches:

Cape Town - Tel. +2721 5101361
salesct@chiorino.co.za
Johannesburg - Tel. +2711 3971268
salesgp@chiorino.co.za

OCEANIA

AUSTRALIA and NEW ZEALAND

CHIORINO AUSTRALIA PTY. LTD. Brisbane
Tel. +61-7-3274 1900
sales@chiorino.com.au
www.chiorino.com.au

Branches:

Adelaide - Tel. +61-8-8445 6722
sales@chiorino.com.au
Melbourne - Tel. +61-3-9799 6333
sales@chiorino.com.au
Sydney - Tel. +61-2-97290701
sales@chiorino.com.au



CHIORINO U.S.A. - Newark



CHIORINO AUSTRALIA - Brisbane

Headquarters and italian associated companies

36

ITALIAN ASSOCIATED COMPANIES



CHIORINO PARMA s.r.l.
Via Quintino Sella, 23/a
Quartiere Crocetta
43100 **Parma**
Tel. +39-0521.292236
Fax +39-0521.980049
chiorinoparma@chiorino.com



CHIORINO VENETO s.r.l.
Via 1° Maggio - Z.I.
31014 **Colle Umberto (TV)**
Tel. +39-0438.430460
Fax +39-0438.430410
chiorinoveneto@chiorino.com

HEADQUARTERS



CHIORINO S.p.A.
BIELLA NORTH PLANT
Via S. Agata, 9
13900 **Biella**
Management offices
Administration and technical offices
Production department



CHIORINO S.p.A.
BIELLA SOUTH PLANT
Via Mongilardi, 20/a
13900 **Biella**
Sales offices
Fabrication departments
Shipping/Receiving

Tel. +39-015.8489.1 - Fax +39-015.849.61.61
chiorino@chiorino.com - www.chiorino.com

CHIORINO GROUP COMPANIES

